

Pump series FP2+

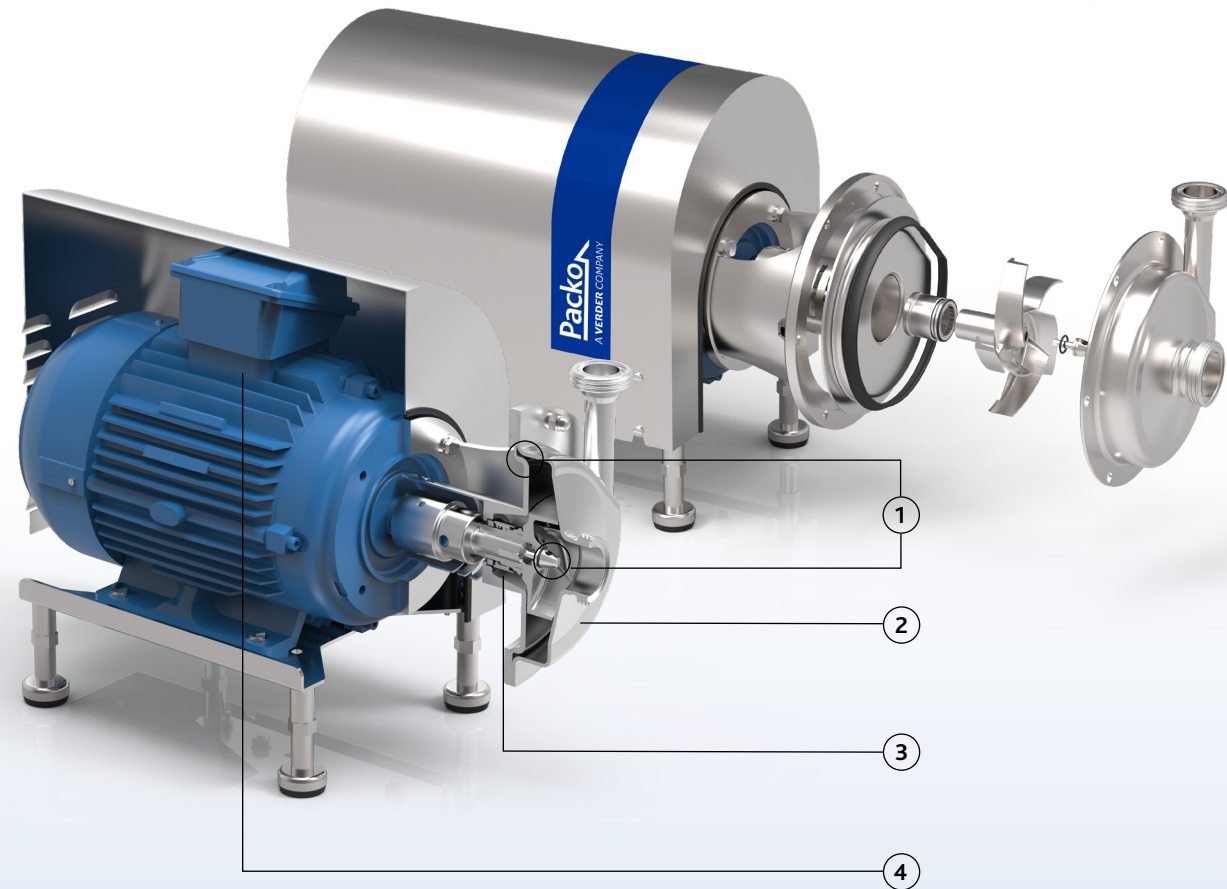

Characteristics

These 3A certified pumps have stainless steel 316L pump casings constructed in thick cold rolled plate, 100% non-porous and extremely smooth. The pumps have open investment cast impellers, constructed in 316L or duplex materials. Thanks to its crevice-free design and electropolishing as a final surface treatment, the FP2+ pump series are perfectly cleanable, resulting in a reliable component for your production process.



FP2+

- 1 Electropolished, easy to clean construction, no bacteria traps and no small clearances in order to clean the area around the O-ring
- 2 Pressed stainless steel in 2B quality plate, extremely smooth
- 3 Large seal cavity to clean mechanical seal properly
- 4 Monobloc execution with std. IEC motors
- 5 Standardized mechanical seals to EN 12756 FDA approved sterile O-ring seals (spring not in contact with the liquid)
- 6 One seal diameter: Ø 33 mm, except for 250 types: Ø 43 mm



Your benefits

- High pump efficiency resulting in lower energy consumption
- Low NPSH values: less risk on cavitation
- Electropolished: perfectly cleanable
- Easy construction and easy maintenance: less downtime
- Standard components
- Easy to install
- 2 mechanical seal diameters for entire range
- Robust construction

Application areas







The Packo 3A certified process pumps of the FP2+ series are used in the most demanding hygienic applications in almost all industries such as dairies, breweries, beverage industry, distilleries, etc.

They are the ideal solution for filtration applications, pasteurisation, evaporating systems, yeast propagation and for CIP cleaning systems as well.

In pharmaceutical and biotech industry they are mainly used for handling Purified Water and as CIP forward pump in cleaning systems.

Pump series

FP2+

Performance	FP2+
max. flow rate	110 m ³ /h
max. differential head	110 m
max. inlet pressure	13 bar
max. liquid viscosity	1000 cP
max. temperature	140°C
impeller type	open
max. free passage	22 mm
max. motor power	45 kW
max. speed	3000/3600 rpm
available frequency	50/60 Hz
Technical specifications	
materials wetted parts	stainless steel 316L or similar
mechanical seal configuration	single sterile, quench, double
available material O-ring	EPDM, FKM, FEP-FKM, FFKM, Silicone
connections	3A approved hygienic fittings only
surface finish	hygienic quality, internal welds hand polished + electropolished (wetted parts 0.8 µm)
certificates & legislation	     

Performance curves at 2900 rpm

FP2+

