



Peristaltic Hose Pump

Spare Parts List

Verderflex Rollit

10 - 50

Version 1.1v-01/2020

Print-No. 01

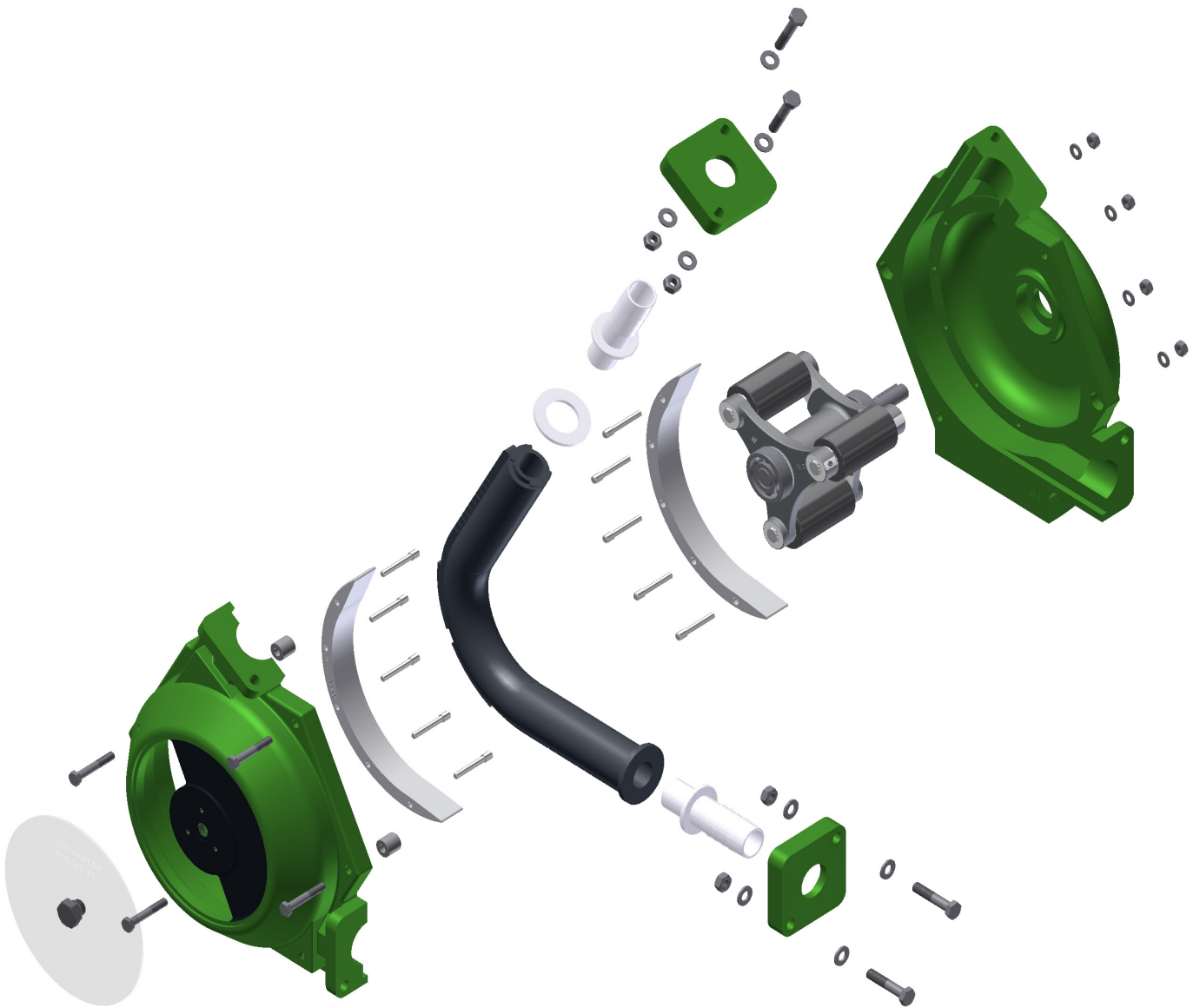



Version 1.1v-01/2020
Print-No. 01

Verderflex Rollit 10 - 50

Rollit 10-50 Spare Parts List

Table 1 contains a list of spares to help maintain and repair the Rollit 10-50 peristaltic pumps. Your Verder distributor will be able to advise you where genuine Verderflex® spares can be purchased.

Pump Layout – Exploded view Rollit 10

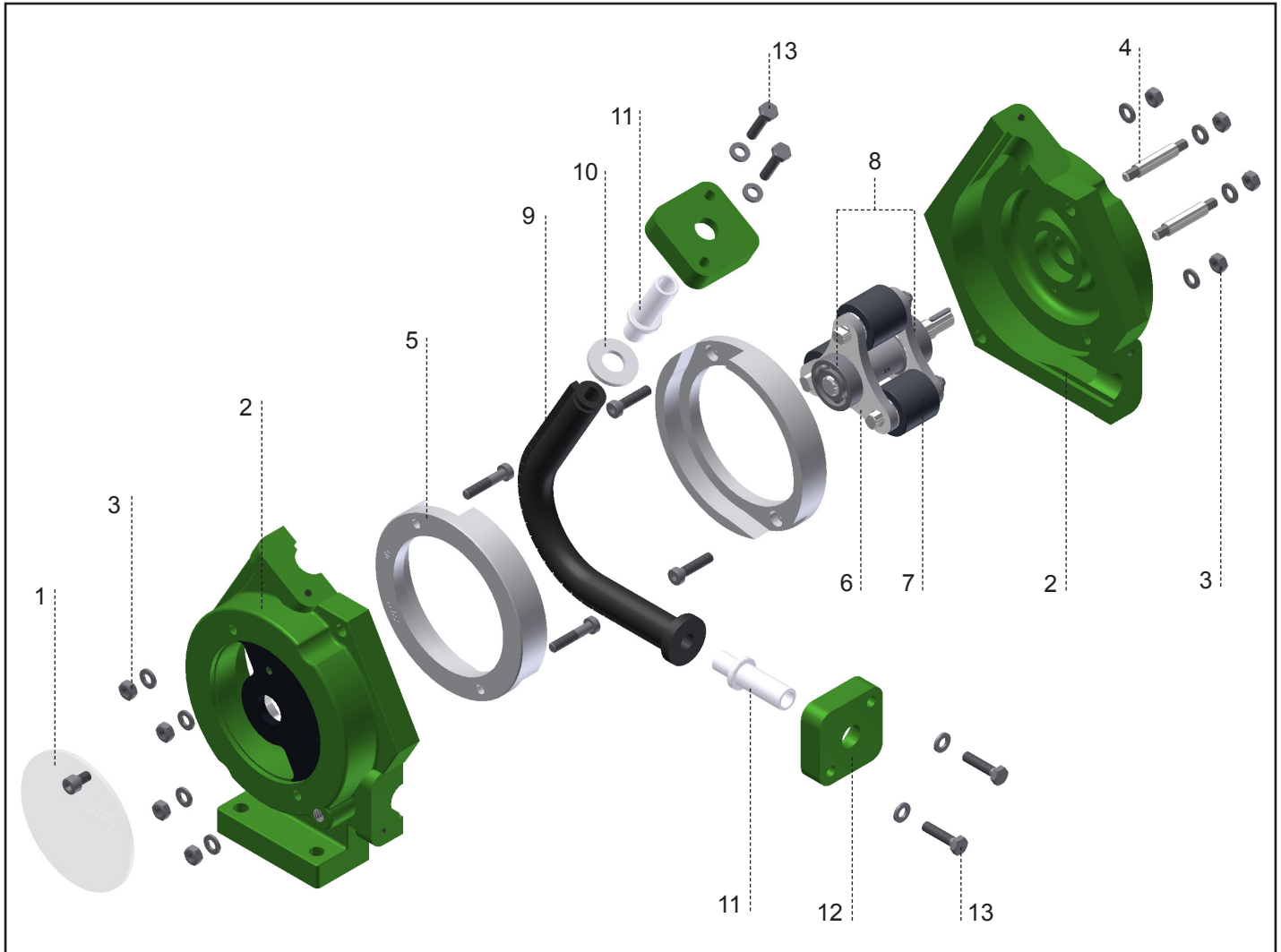

Figure 2 Layout - Rollit 10 exploded view

- | | | | | | |
|---|--------------------------------------|----|-------------------|----|-------------------------|
| 1 | Casing cover | 6 | Rotor complete | 11 | Hose tail |
| 2 | Pump casing | 7 | Rollers complete | 12 | Counter flange |
| 3 | Casing fasteners | 8 | Bearing | 13 | Counter flange fastener |
| 4 | Centering pin with male
thread M6 | 9 | Pump hose | | |
| 5 | Teflon inserts complete | 10 | Snap Closure Ring | | |

Pump Layout – Exploded view Rollit 15-50

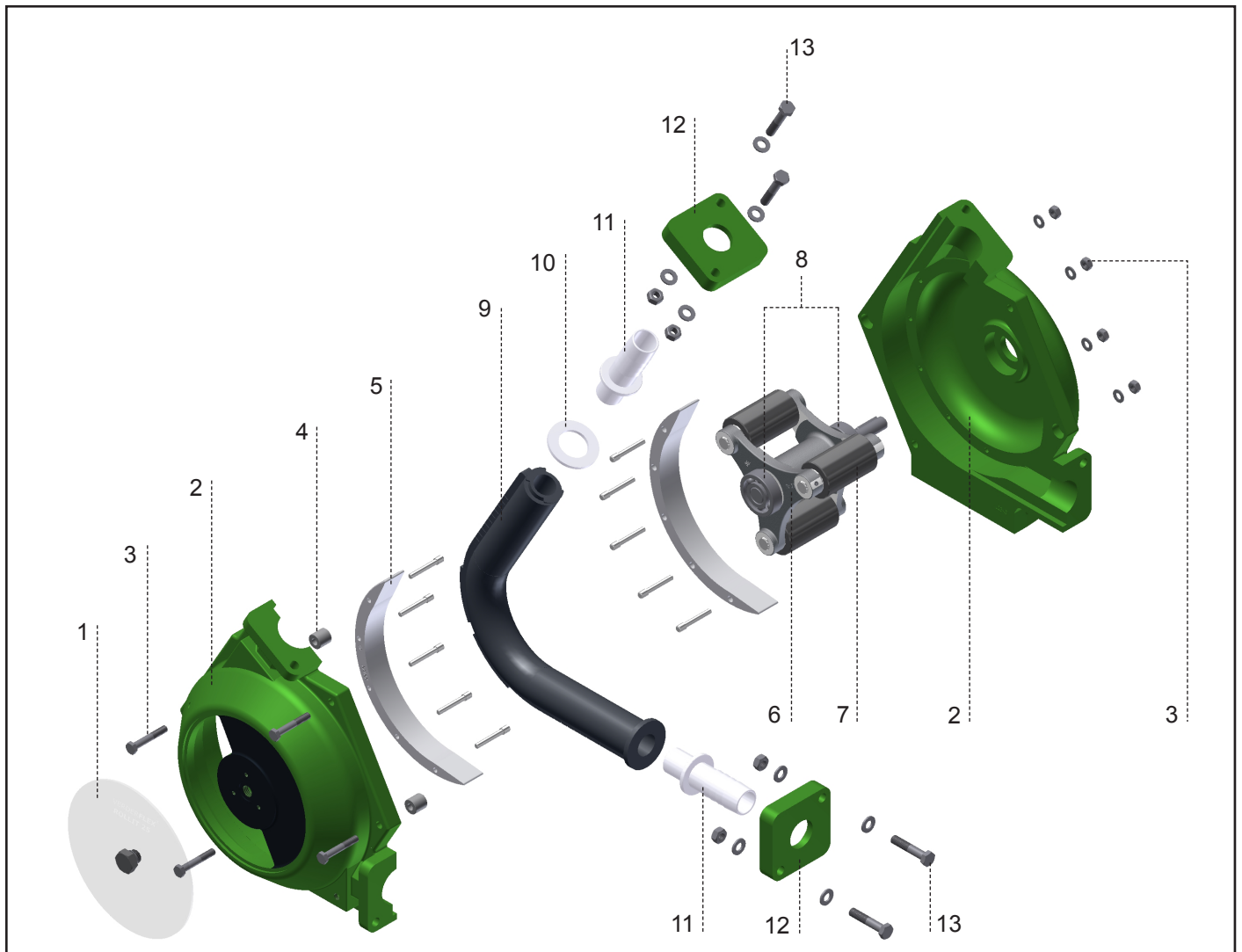

Figure 2 Layout - Rollit 15-50 exploded view

- | | | | | | |
|---|-------------------------|----|-------------------|----|-------------------------|
| 1 | Casing cover | 6 | Rotor complete | 11 | Hose tail |
| 2 | Pump casing | 7 | Rollers complete | 12 | Counter flange |
| 3 | Casing fasteners | 8 | Bearing | 13 | Counter flange fastener |
| 4 | Centering bush | 9 | Pump hose | | |
| 5 | Teflon inserts complete | 10 | Snap Closure Ring | | |

Table 1 Rollit 10-50 Spare Parts List



Ref	Item	Part No		Qty	Image
1	Casing cover Plexiglass <i>(for Casing Cover SS meets Atex see Table 1.1)</i>	R 10	114.100031	1	
		R 15	114.100032		
		R 25	114.100033		
		R 35	114.100034		
		R 50	114.100035		
3	Casing fasteners	R 10	M6 Steel BZP	4	
		R 15	M8 x 50 Steel BZP		
		R 25	M8 x 50 Steel BZP		
		R 35	M8 x 60 Steel BZP		
		R 50	M8 x 70 Steel BZP		
4	Centering pin with male thread M6 <i>Set of 2 Pieces</i>	R 10	-	1	
	Centering bush <i>Set of 2 Pieces</i>	R 15	-		
		R 25	-		
		R 35	-		
		R 50	-		
					

Table 1 Rollit 10-50 Spare Parts List



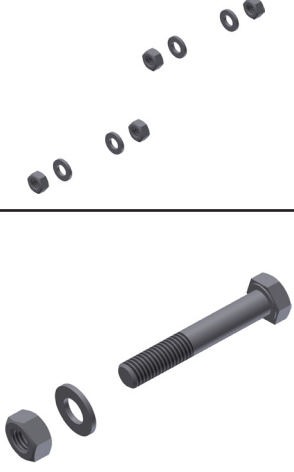

Ref	Item	Part No		Qty	Image	
5	Teflon inserts complete <i>Set of 2 Pieces</i> <i>(for Teflon inserts meets ATEX see Table 1.1)</i>	R 10	114.100021	1		
		R 15	114.100022			
		R 25	114.100023			
		R 35	114.100024			
		R 50	114.100025			
6	Rotor complete	R 10	114.100026	1		
		R 15	114.100027			
		R 25	114.100028			
		R 35	114.100029			
		R 50	114.100030			
7	Rollers complete <i>Set of 3 Pieces</i>	R 10	114.100016	1		
		R 15	114.100017			
		R 25	114.100018			
		R 35	114.100019			
		R 50	114.100020			
8	Bearing	R 10	114.100067	2		
		R 15	114.100068			
		R 25	114.100069			
		R 35	114.100070			
		R 50	114.100071			

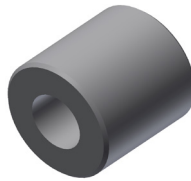
Table 1 Rollit 10-50 Spare Parts List (continued)



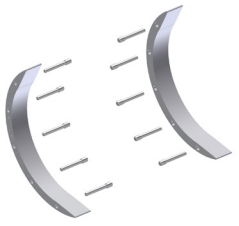
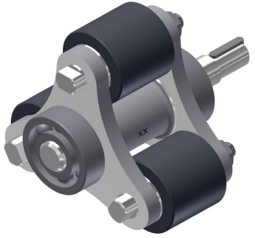

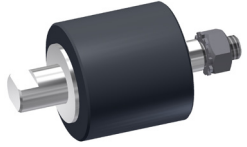
Ref	Item	Part No			Qty	Image
10	Snap closure ring	R 10	114.100051		1	
		R 15	114.100052			
		R 25	114.100053			
		R 35	114.100054			
		R 50	114.100055			
11	Hose tail	R 10 nominal size 14	PP	114.100041	1	
			SS 1.4571	114.100046		
		R 15 nominal size 25	PP	114.100042		
			SS 1.4571	114.100047		
		R 25 nominal size 31	PP	114.100043		
			SS 1.4571	114.100048		
		R 35 nominal size 51	PP	114.100044		
			SS 1.4571	114.100049		
R 50 nominal size 75	PP	114.100045				
	SS 1.4571	114.100050				
11.1	Hose tail with tread DIN ISO 228	R 10 nominal size 1/4"	SS 1.4571	on request	1	
		R 15 nominal size 3/4"	SS 1.4571	on request		
		R 25 nominal size 1"	SS 1.4571	on request		
		R 35 nominal size 1 1/2"	SS 1.4571	on request		
		R 50 nominal size 2 1/2"	SS 1.4571	on request		
11.2	Hose tail with tread NPT	R 10 nominal size 1/4"	SS 1.4571	on request	1	
		R 15 nominal size 3/4"	SS 1.4571	on request		
		R 25 nominal size 1"	SS 1.4571	on request		
		R 35 nominal size 1 1/2"	SS 1.4571	on request		
		R 50 nominal size 2 1/2"	SS 1.4571	on request		

Table 1 Rollit 10-50 Spare Parts List (continued)



Ref	Item	Part No			Qty	Image
11.3	Hose tail with tread BSPT	R 10 nominal size 1/2"	SS 1.4571	on request	1	
		R 15 nominal size 3/4"	SS 1.4571	on request		
		R 25 nominal size 1"	SS 1.4571	on request		
		R 35 nominal size 1 1/2"	SS 1.4571	on request		
		R 50 nominal size 2 1/2"	SS 1.4571	on request		
12	Counter flange Set of 2 pieces	R 10	on request		1	
		R 15	on request			
		R 25	on request			
		R 35	on request			
		R 50	on request			
12.1	Thread flange DIN 2633	R 10 nominal size DN10	SS 1.4571	on request	1	
		R 15 nominal size DN 20	SS 1.4571	on request		
		R 25 nominal size DN 25	SS 1.4571	on request		
		R 35 nominal size DN 40	SS 1.4571	on request		
		R 50 nominal size DN 65	SS 1.4571	on request		
12.2	Thread flange ANSI B 16.5 150 lbs	R 10 nominal size 1/2"	SS 1.4571	on request	1	
		R 15 nominal size 3/4"	SS 1.4571	on request		
		R 25 nominal size 1"	SS 1.4571	on request		
		R 35 nominal size 1 1/2"	SS 1.4571	on request		
		R 50 nominal size 2 1/2"	SS 1.4571	on request		

Table 1 Rollit 10-50 Spare Parts List (continued)

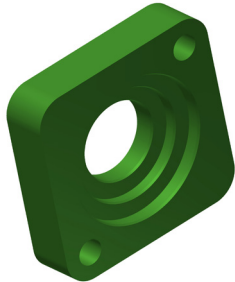

Ref	Item	Part No		Qty	Image
13	Counter flange fastener: - bolt and washer	R 10	M6 x 25 Steel BZP	4	
		R 15	M8 x 30 Steel BZP		
		R 25	M10 x 40 Steel BZP		
	Counter flange fastener: - bolt, washer and nut.	R 35	M12 x 55 Steel BZP		
		R 50	M12 x 60 Steel BZP		

Table 1.1 Rollit 10-50 Spare Parts List Meets Atex





Ref	Item	Part No		Qty	Image
1	Casing cover SS Meets Atex	R 10	114.100036	1	
		R 15	114.100037		
		R 25	114.100038		
		R 35	114.100039		
		R 50	114.100040		
5	Teflon inserts complete Meets Atex <i>Set of 2 Pieces</i>	R 10	114.100021.Y	1	
		R 15	114.100022.Y		
		R 25	114.100023.Y		
		R 35	114.100024.Y		
		R 50	114.100025.Y		

Table 2 Rollit 10-50 Hose options

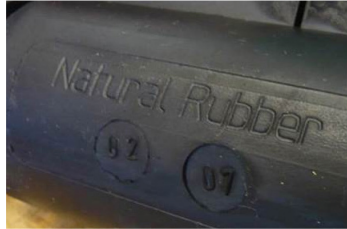

Item Description	Part No		Qty	Image
Hose options NR	R 10	114.100001	1	
	R 15	114.100004		
	R 25	114.100007		
	R 35	114.100010		
	R 50	114.100013		
Hose options NRF	R 10	114.100003	1	
	R 15	114.100006		
	R 25	114.100009		
	R 35	114.100012		
	R 50	114.100015		
Hose options Neoprene	R 10	114.100002	1	
	R 15	114.100005		
	R 25	114.100008		
	R 35	114.100011		
	R 50	114.100014		

Table 3 Rollit 10-50 Special Grease

Item Description	Part No	Qty
Rollit Special Grease	114.100072	250 gr.
	114.100106	1000 gr.