

MICRODOS

Dosing systems



I MANUALE DI PROGRAMMAZIONE

UK PROGRAMMING INSTRUCTIONS

F MANUEL DE RÉGLAGE

E MANUAL DE REGULACIÓN

**POMPE / PUMPS
POMPES / BOMBAS**

ME3 – PH/RX

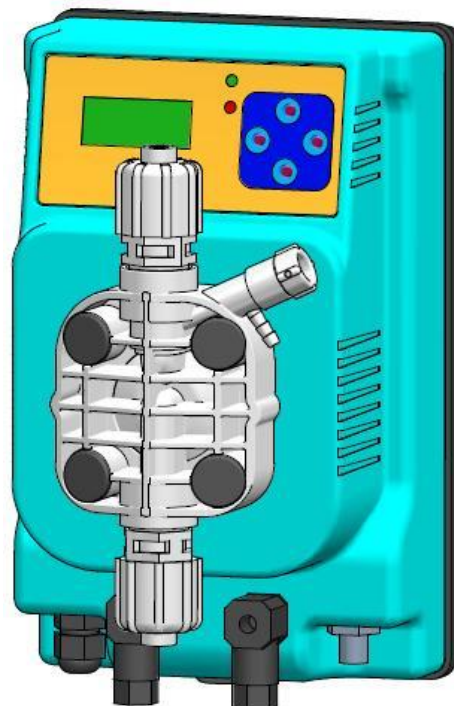

DESCRIZIONE PANNELLO FRONTALE

	<ol style="list-style-type: none"> 1. Display LCD 8 x 2 retroilluminato 2. Led verde: <ul style="list-style-type: none"> ▪ fisso = POMPA ACCESA ▪ lampeggiante = POMPA IN ALLARME 3. Led rosso: segnala le iniezioni 4. Tasto CAL: <ul style="list-style-type: none"> ▪ fa entrare in programmazione ▪ Salva le modifiche 5/6. Tasto - e +: <ul style="list-style-type: none"> ▪ Fa navigare all'interno del menu ▪ Modifica il valore dei parametri 7. Tasto ESC/SBY: <ul style="list-style-type: none"> ▪ mette la pompa in stand_by ▪ fa uscire dal menu
--	--

FUNZIONI GENERALI DELLA POMPA :

- **MENU IN 4 LINGUE**: ITALIANO, INGLESE, FRANCESE, SPAGNOLO
- SCELTA DI CONTROLLO DEL **pH** o **mV (Rx)** DA PROGRAMMA
- 3 POSSIBILI **TIPI DI FUNZIONAMENTO**: COSTANTE, ON/OFF, PROPORZIONALE
- **ALLARME TEMPORALE** DI SOVRADOSAGGIO
- **RITARDO DI ACCENSIONE**
- **RIPRISTINO** DEI PARAMETRI DI DEFAULT
- CONTROLLO DI **FLUSSO** D'ACQUA
- CONTROLLO DI **LIVELLO**
- SEGNALE DI **OVER RANGE** E **UNDER RANGE** DELLA MISURA
- STOP DEL DOSAGGIO (**STAND_BY**)
- SEGNALE DELLA **PORTATA %** ISTANTE PER ISTANTE

REGOLAZIONI DELLA CASA

tipo pH:

- FUNZIONAMENTO: **Prop**
- SETPOINT: **7.2 pH**
- VERSO DI DOSAGGIO: **Acid**
- FREQUENZA DI INIEZIONE: **100% (150 imp/min)**
- TEMPO DI ALLARME : **0unit (disabilitato)**
- RITARDO DI ACCENSIONE: **0 sec**

tipo Rx:

- FUNZIONAMENTO: **Prop**
- SETPOINT: **730mV**
- VERSO DI DOSAGGIO: **Oxid**
- FREQUENZA DI INIEZIONE: **100% (150 imp/min)**
- TEMPO DI ALLARME : **0unit (disabilitato)**
- RITARDO DI ACCENSIONE: **0 sec**

RIPRISTINO DELLE REGOLAZIONI DELLA CASA



Premere e rilasciare rapidamente il tasto **CAL** per entrare in programmazione e poi con tasti **+** e **-** visualizzare **"Riprist. Enter"**.
 Premere **CAL** per confermare. Automaticamente la pompa torna in misura con in memoria i valori di programmazione e calibrazione di fabbrica.

CONNESSIONI DELLA POMPA

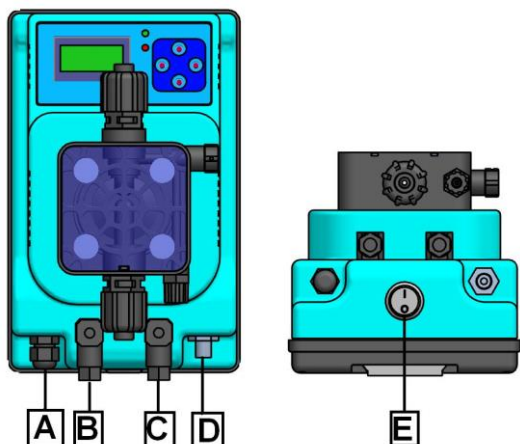

- A** - è il cavo di alimentazione elettrica , 230 V- 50Hz (a richiesta 115 ~).
- B** - è il connettore della sonda di livello (contatti 3 e 4). **OPTIONAL**
- C** - è il connettore del sensore di flusso (contatti 3 e 4). **OPTIONAL**
- D** - è il connettore BNC della sonda pH o Orp (Rx).
- E** - è l'interruttore ON_OFF. **OPTIONAL**

STAND BY (STOP)

	<p>La pressione prolungata del tasto ESC/SBY per 2 secondi durante il funzionamento pone la pompa in stato di stand by:</p> <ol style="list-style-type: none"> 1) CESSA IL DOSAGGIO 2) LED verde di on lampeggiante.
<p>Stop 0% 8.21pH</p>	<p>3) Nel funzionamento PROPORZIONALE il display visualizza: "Stop 0%" sulla prima riga e la misura attuale sulla seconda riga (vedi figura a lato, l'esempio si riferisce al tipo pH)</p>
<p>Stop 50% 8.21pH</p>	<p>3) Nel funzionamento Manuale e ON-OFF il display visualizza: "Stop" e la % di frequenza programmata sulla prima riga e la misura attuale sulla seconda riga (vedi figura a lato, l'esempio si riferisce al tipo pH).</p>
<p>La nuova pressione per 2 secondi del tasto ESC/SBY fa tornare la pompa nello stato di funzionamento.</p>	

STRUTTURA DEL MENU

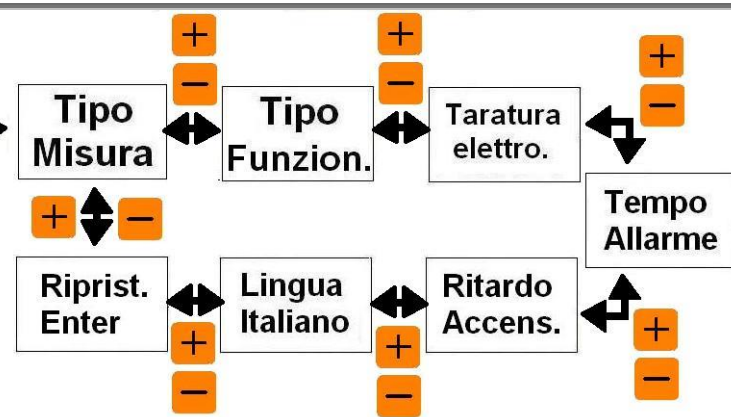
		<p>Premendo e rilasciando rapidamente il tasto CAL si entra in programmazione. Si naviga dentro il menu con i tasti + e -.</p> <p>Si entra nei sottomenu premendo il tasto CAL.</p>
--	---	---

SCELTA DELLA LINGUA

<p>Lingua Italiano</p>	<p>Premere e rilasciare rapidamente il tasto CAL e scorrere il menu con i tasti + e - finchè sul display appare la scritta della scelta della lingua. Premere il tasto CAL e poi con i tasti + e - scegliere : Lingua Italiano</p> <p>Premere CAL per confermare ed ESC per tornare in misura</p>
-------------------------------	---

SCELTA DEL TIPO DI MISURA

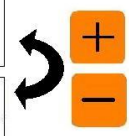
<p>Tipo Misura</p> 	<p>Tipo pH</p> <p>Tipo Rx</p> 	<p>Premere e rilasciare rapidamente il tasto CAL e scorrere il menu con i tasti + e - finchè sul display appare la scritta "Tipo Misura". Premere CAL per entrare e con i tasti + e - scegliere pH oppure Rx..</p> <p>Premere CAL per confermare ed ESC per tornare in misura.</p>
--	---	--

RITARDO DI ACCENSIONE

<p>Ritardo 7.32pH</p>	<p>CHE COSA E'? Il ritardo di accensione è il tempo in secondi (da 0-999sec) che la pompa attende dopo la sua accensione per dosare il prodotto chimico. Durante questo tempo viene visualizzato il messaggio "Ritardo" sulla prima riga del display e la misura sulla seconda riga del display (vedi figura a lato). Durante questo tempo la pompa è disabilitata al dosaggio ma è possibile accedere al menu per modificare parametri e calibrazioni.</p>
<p>Ritardo Accens.</p> 	<p>MODIFICA DEL RITARDO DI ACCENSIONE</p> <p>Premere e rilasciare rapidamente il tasto CAL e scorrere il menu con i tasti + e - finchè sul display appare la scritta "Ritardo Accens.". Premere CAL per entrare e con i tasti + e - scegliere i secondi di ritardo di accensione da 0 a 999. Premere CAL per confermare ed ESC per tornare in misura.</p>

ALLARME TEMPORALE

<p>Tal 29% 8.21pH</p>	<p>CHE COSA E'? L'allarme temporale è espresso in unit (unità) di dosaggio. Una unità di dosaggio equivale a 150 iniezioni di prodotto chimico. Il conteggio delle iniezioni parte da 0 nell'istante in cui la pompa inizia il dosaggio dopo l'accensione, si incrementa durante il dosaggio, si sospende durante l'allarme di livello e durante lo stand_by, si resetta se manca l'alimentazione elettrica, se la misura raggiunge il setpoint e durante l'allarme di flusso. Quando il conteggio raggiunge il valore del</p>
----------------------------------	---

parametro memorizzato nel Tempo di Allarme, la pompa va in allarme:

- 1) CESSA IL DOSAGGIO (nessuna tensione al magnete)
- 2) LED verde di on lampeggia
- 3) IL DISPLAY visualizza: sulla prima riga “**Tal** “ e la portata percentuale, sulla seconda riga invece visualizza la misura.



La pressione prolungata del tasto di **ESC** per 2 secondi fa tornare la pompa nello stato di FUNZIONAMENTO ed azzerà il conteggio che riparte immediatamente quando la pompa ricomincia a dosare.

Tempo Allarme



Tempo 0 unit

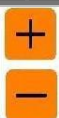

MODIFICA DELL'ALLARME TEMPORALE

Premere e rilasciare rapidamente il tasto **CAL** e scorrere il menu con i tasti **+** e **-** finché sul display appare la scritta “Tempo Allarme”. Premere **CAL** per entrare e con i tasti **+** e **-** scegliere le unità di allarme temporale da 0 a 120 unit. Premere **CAL** per confermare ed **ESC** per tornare in misura

MOD	l/h	1 unit	Tempo Allarme= 2000cc : (cc_unit)
ME3-PH/RX 04/12	4	66.6cc	30 unit
ME3-PH/RX 04/18	4	66.6cc	30 unit
ME3-PH/RX 05/10	5	83.3cc	24 unit
ME3-PH/RX 06/15	6	100cc	20 unit
ME3-PH/RX 10/2	10	166.6cc	12 unit
ME3-PH/RX 26/2	26	433.3cc	5 unit
ME3-PH/RX 30/1	30	500cc	4 unit

Esempio di calcolo del Tempo di Allarme se si vogliono iniettare 2 litri (=2000cc) di prodotto massimo alla contropressione di targa della pompa.

NB: L'allarme temporale non ha effetto sul funzionamento manuale

CONTROLLO DI LIVELLO



Livello
7.32pH

La chiusura del contatto di livello, libero da tensione, durante il funzionamento della pompa, in qualsiasi modalità essa si trovi, provoca:

- 1) la cessazione dell'attività di dosaggio
- 2) l'accensione lampeggiante del led verde on
- 3) Il display visualizza alternativamente sulla prima riga la scritta “**Livello**” mentre sulla seconda riga permane la misura attuale

La riapertura del contatto di livello fa tornare la pompa, nello stato di FUNZIONAMENTO congruente con gli ingressi attuali della pompa.

NB: l'allarme di livello sospende (ma non resetta) il conteggio dell'allarme temporale.

CONTROLLO DI FLUSSO



Flusso
7.32pH

La chiusura del contatto di flusso, libero da tensione, durante il funzionamento della pompa, in qualsiasi modalità essa si trovi, provoca:

- 1) la cessazione dell'attività di dosaggio
- 2) l'accensione lampeggiante del led verde on

- 3) Il display visualizza alternativamente sulla prima riga la scritta “**Flusso**” mentre sulla seconda riga permane la misura attuale

La riapertura del contatto di flusso fa tornare la pompa nello stato di FUNZIONAMENTO congruente con gli ingressi attuali della pompa.

NB: l'allarme di flusso resetta il conteggio dell'allarme temporale.

SEGNALI DI O.R e U.R

Il display segnala O.R (Over Range) quando la misura supera il limite massimo misurabile.

Il display segnala U.R (Under Range) quando la misura scende al di sotto del limite minimo misurabile.

Il led verde di on lampeggia velocemente.

Se la pompa è in funzionamento Manuale il dosaggio non viene bloccato.

Se la pompa è in funzionamento ON-OFF e Proporzionale il dosaggio viene bloccato.

pH range: 0-14pH

mV range: 0-1000mV

POSSIBILI FUNZIONAMENTI



	<p>Ci sono 3 possibili funzionamenti:</p> <p>Tipo manuale: dosaggio costante ad un numero di impulsi al minuto definito in programmazione come nel prossimo paragrafo.</p> <p>Tipo Proporzionale: dosaggio proporzionale alla distanza della misura dal setpoint desiderato. Range di proporzionalità : 1pH o 100mV</p> <p>Tipo On-Off : dosaggio di tipo costante che si attiva nel momento in cui la misura si allontana dal setpoint. Hysteresi totale centrata sul Setpoint: 0.1pH o 10mV</p>
--	--

PROGRAMMAZIONE DEL FUNZIONAMENTO MANUALE (COSTANTE) E VISUALIZZAZIONE



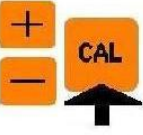
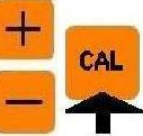

	<p>Premere e rilasciare rapidamente il tasto CAL e poi i tasti + e - per fare apparire "Tipo Funzion." Premere CAL e quindi con i tasti + e - scegliere "Tipo Manual" e confermare con CAL. Appare "Freq." con la percentuale precedentemente scelta. Modificare con + e - tale valore e confermare la scelta con CAL. Premere ESC per tornare in misura con il funzionamento di dosaggio Manuale appena programmato.</p> <p>Il numero di iniezioni che la pompa fa al minuto è pari alla percentuale scelta della frequenza massima. Esempio : 80% significa 120 impulsi al minuto cioè $150\text{imp/min} \times 0.8 = 120\text{ imp/min}$</p> <p>Nel funzionamento Manuale il display scrive sulla prima riga "Man." e la percentuale di frequenza di iniezione programmata. Sulla seconda riga è visualizzata la misura.</p>
--	--

PROGRAMMAZIONE DEI FUNZIONAMENTI NEL TIPO pH

PROGRAMMAZIONE DEL FUNZIONAMENTO ON-OFF pH E VISUALIZZAZIONE

Tipo On-Off		Premere e rilasciare rapidamente il tasto CAL e poi i tasti + e - fino a visualizzare "Tipo Funzion." Premere CAL e quindi con i tasti + e - fare apparire "Tipo On-Off". Quindi confermare con CAL .
SetPoint 7.00pH		Appare il valore del Setpoint precedentemente memorizzato. Premere + e - per modificarlo e il tasto CAL per confermare la modifica.
SetPoint Acid		Appare il verso del dosaggio Acid oppure Alk precedentemente memorizzato. Con + e - scegliere il verso e confermare con CAL .
SetPoint Alk		Scegliere Acid se si vuole dosare per valori del pH superiori al Setpoint. Scegliere Alk se si vuole dosare per valori di pH inferiori al Setpoint.
Freq 100%		Appare il valore della percentuale della frequenza massima di iniezioni (150 imp/min) precedentemente memorizzato. Modificarlo con + e - e confermare con CAL . Premere ESC per tornare in misura con il nuovo funzionamento di dosaggio On-Off appena programmato
On 100% 7.11pH		Nel funzionamento On-Off se la pompa dosa il display scrive sulla prima riga "On" e la percentuale di iniezioni programmata, se la pompa non dosa il display scrive sulla prima riga "Off" e la suddetta percentuale. Sulla seconda riga è visualizzata la misura.

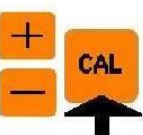
PROGRAMMAZIONE DEL FUNZIONAMENTO PROPORZIONALE AL pH E VISUALIZZAZIONE

Tipo Prop		Range di proporzionalità = 1pH Premere e rilasciare rapidamente il tasto CAL e poi i tasti + e - fino a visualizzare "Tipo Funzion." Premere CAL e quindi con i tasti + e - visualizzare "Tipo Prop" e confermare con CAL .
SetPoint 7.00pH		Appare il valore del Setpoint precedentemente memorizzato. Premere + e - per modificarlo e il tasto CAL per confermare la modifica.
SetPoint Acid		Appare il verso del dosaggio Acid oppure Alk precedentemente memorizzato. Con + e - si passa dall'uno all'altro e confermare con CAL .
SetPoint Alk		Scegliere Acid se si vuole dosare per valori del pH superiori al Setpoint. Scegliere Alk se si vuole dosare per valori di pH inferiori al Setpoint.
Freq 100%		Appare il valore della percentuale della frequenza massima di iniezioni (150 imp/min) precedentemente memorizzato. Modificarlo con + e - e confermare con CAL . Premere ESC per tornare in misura con il nuovo funzionamento di dosaggio Proporzionale appena programmato.
Prop 100% 7.11pH		Nel funzionamento Proporzionale il display scrive sulla prima riga "Prop" e la percentuale di iniezioni che il magnete sta facendo rispetto alla frequenza di iniezioni programmata. Sulla seconda riga è visualizzata la misura.



In qualsiasi punto di programmazione del setpoint se non viene premuto alcun tasto (+, -, CAL) durante 60 secondi, la pompa esce dalla programmazione con i parametri nuovi fino a quel momento memorizzati.

CALIBRAZIONE DELLA SONDA TIPO pH

Attenzione,

Assicurarsi che le soluzioni tampone usate nella calibrazione corrispondano sempre al valore indicato e che non siano inquinate.

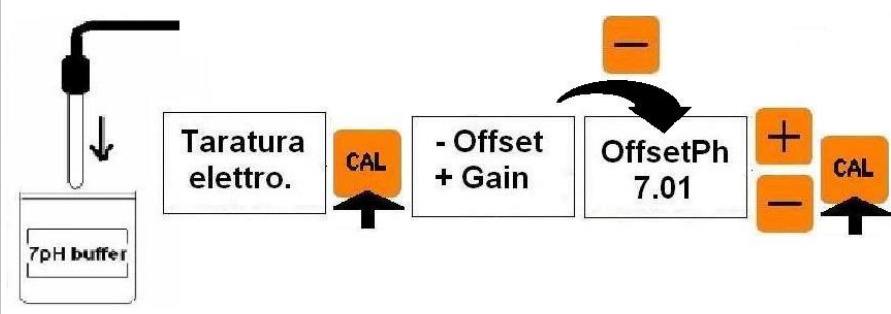
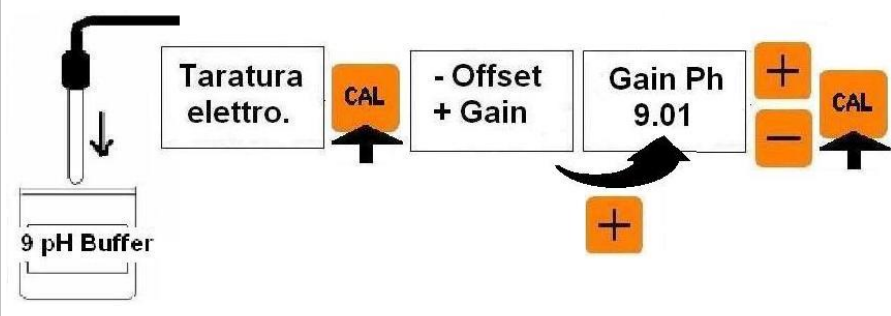
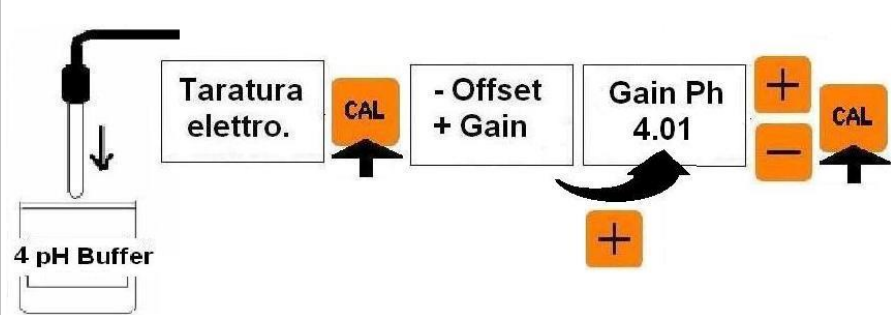
<p>BUFFER 7.01pH</p> 	<p>TARATURA DELL'OFFSET</p> <p>Immergere la sonda di pH nella soluzione tampone a pH 7. Attendere la stabilizzazione della lettura sul display. Premere e rilasciare rapidamente il tasto CAL e poi i tasti + e - fino a visualizzare "Taratura elettro". Premere CAL e quindi il tasto - per effettuare la taratura dell'offset della sonda. Regolare (se necessario) il valore di lettura del tampone con i tasti + e - e poi confermare con CAL. Se compare il messaggio "Taratura impossibili" la taratura non è stata effettuata. Leggere il paragrafo che segue : MESSAGGI DELLA POMPA. Se non appare alcun messaggio la taratura è stata effettuata.</p>
<p>BUFFER 9.01pH</p>  <p>BUFFER 4.01pH</p> 	<p>TARATURA DEL GAIN</p> <p>Pulire la sonda con acqua e poi immergerla nella soluzione tampone a pH 9 oppure 4. Attendere la stabilizzazione della lettura sul display. Premere e rilasciare rapidamente il tasto CAL e poi i tasti + e - fino a visualizzare "Taratura elettro". Premere CAL e quindi il tasto + per effettuare la taratura del gain della sonda. Regolare (se necessario) il valore di lettura del tampone con i tasti + e - e poi confermare con CAL. Se compare il messaggio "Taratura impossibili" la taratura non è stata effettuata. Leggere il paragrafo che segue : MESSAGGI DELLA POMPA. Se non appare alcun messaggio la taratura è stata effettuata.</p>

MESSAGGI DELLA POMPA



<p>Taratura impossibili</p>	<p>INDICA CHE LA TARATURA DELL'ELETTRODO E' IMPOSSIBILE. E' NECESSARIO RIPETERLA.</p> <p>Se dopo aver ripetuto la calibrazione appare nuovamente il messaggio:</p> <ol style="list-style-type: none">Controllare che la soluzione tampone non sia inquinata (eventualmente sostituirla).Controllare che la soluzione tampone scelta sul display durante la calibrazione sia quella effettivamente usata.La sonda di pH potrebbe essere invecchiata (sostituirla).
------------------------------------	--

PROGRAMMAZIONE DEI FUNZIONAMENTI NEL TIPO Rx (mV)

PROGRAMMAZIONE DEL FUNZIONAMENTO ON-OFF Rx E VISUALIZZAZIONE

Tipo On-Off		Premere e rilasciare rapidamente il tasto CAL e poi i tasti + e - fino a visualizzare "Tipo Funzion." Premere CAL e quindi con i tasti + e - fare apparire "Tipo On-Off". Quindi confermare con CAL .
SetPoint 700mV		Appare il valore del Setpoint precedentemente memorizzato. Premere + e - per modificarlo e il tasto CAL per confermare la modifica.
SetPoint Oxid		Appare il verso del dosaggio Oxid oppure Red precedentemente memorizzato. Con + e - scegliere il verso e confermare con CAL .
SetPoint Red		Scegliere Red se si vuole dosare per valori di mV superiori al Setpoint. Scegliere Oxid se si vuole dosare per valori di mV inferiori al Setpoint.
Freq 100%		Appare il valore della percentuale della frequenza massima di iniezioni (150 imp/min) precedentemente memorizzata. Modificarla con + e - e confermare con CAL . Premere ESC per tornare in misura con il nuovo funzionamento di dosaggio On-Off appena programmato
On 100% 510mV		Nel funzionamento On-Off se la pompa dosa il display scrive sulla prima riga "On" e la percentuale di iniezioni programmata, se la pompa non dosa il display scrive sulla prima riga "Off" e la suddetta percentuale. Sulla seconda riga è visualizzata la misura.

PROGRAMMAZIONE DEL FUNZIONAMENTO PROPORZIONALE AL Rx E VISUALIZZAZIONE

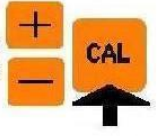
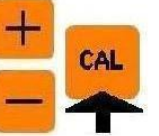
Tipo Prop		Range di proporzionalità = 100mV Premere e rilasciare rapidamente il tasto CAL e poi i tasti + e - fino a visualizzare "Tipo Funzion." Premere CAL e quindi con i tasti + e - visualizzare "Tipo Prop" e confermare con CAL .
SetPoint 700mV		Appare il valore del Setpoint precedentemente memorizzato. Premere + e - per modificarlo e il tasto CAL per confermare la modifica.
SetPoint Oxid		Appare il verso del dosaggio Oxid oppure Red precedentemente memorizzato. Con + e - si passa dall'uno all'altro e confermare con CAL .
SetPoint Red		Scegliere Red se si vuole dosare per valori di mV superiori al Setpoint. Scegliere Oxid se si vuole dosare per valori di mV inferiori al Setpoint.
Freq 100%		Appare il valore della percentuale della frequenza massima di iniezioni (150 imp/min) precedentemente memorizzato. Modificarla con + e - e confermare con CAL . Premere ESC per tornare in misura con il nuovo funzionamento di dosaggio Proporzionale appena programmato.
Prop100% 500mV		Nel funzionamento Proporzionale il display scrive sulla prima riga "Prop" e la percentuale di iniezioni che il magnete sta facendo rispetto alla frequenza di iniezioni programmata. Sulla seconda riga è visualizzata la misura.



In qualsiasi punto di programmazione del setpoint se non viene premuto alcun tasto (+, -, CAL) durante 60 secondi, la pompa esce dalla programmazione con i parametri nuovi fino a quel momento memorizzati.

CALIBRAZIONE DELLA SONDA TIPO Rx

Attenzione,

Assicurarsi che le soluzioni tampone usate nella calibrazione corrispondano sempre al valore indicato e che non siano inquinate.

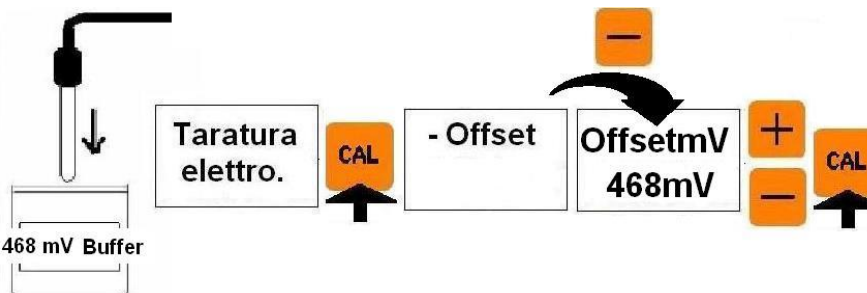
<p>BUFFER 468mV</p> 	<p>TARATURA DELL'OFFSET</p> <p>Immergere la sonda di Rx nella soluzione tampone a 468mV. Attendere la stabilizzazione della lettura. Premere e rilasciare rapidamente il tasto CAL e poi i tasti + e - fino a visualizzare "Taratura elettro". Premere CAL e quindi il tasto - per effettuare la taratura dell'offset della sonda. Regolare (se necessario) il valore di lettura del tampone con i tasti + e - e poi confermare con CAL.</p> <p>Se compare il messaggio "Taratura imposs" la taratura non è stata effettuata. Leggere il paragrafo che segue : MESSAGGI DELLA POMPA.</p> <p>Se non appare alcun messaggio la taratura è stata effettuata.</p>
---	---

MESSAGGI DELLA POMPA

<p>Taratura imposs</p>	<p>INDICA CHE LA TARATURA DELL'ELETTRODO E' IMPOSSIBILE. E' NECESSARIO RIPETERLA.</p> <p>Se dopo aver ripetuto la calibrazione appare nuovamente il messaggio:</p> <ul style="list-style-type: none">a) Controllare che la soluzione tampone non sia inquinata (eventualmente sostituirla).b) Controllare che la soluzione tampone scelta sul display durante la calibrazione sia quella effettivamente usata.c) La sonda di Orp (Rx) potrebbe essere invecchiata (sostituirla).
-------------------------------	---

FRONTAL PANEL DESCRIPTION

	<p>1. Display LCD 8 x 2 backlight</p> <p>2. Green Led: ▪ fix = PUMP ON ▪ blinking = PUMP IN ALARM</p> <p>3. Red Led: indicates the injections</p> <p>4. CAL button : ▪ allows to enter in programming ▪ saves the changes</p> <p>5/6. – and + buttons : ▪ allows to navigate through the menu ▪ Modify the parameters values</p> <p>7. ESC/STBY button: ▪ puts the pump in stand_by mode ▪ allows to exit the menu</p>
--	--

GENERAL FUNCTIONS OF THE PUMP :

- **4 LANGUAGES MENU:** ITALIAN, ENGLISH, FRENCH, SPANISH
- **pH or mV (Rx) CONTROL CHOICE**
- **3 POSSIBLE TYPES OF FUNCTIONING:** MANUAL, ON/OFF, PROPORTIONAL
- **ALARM TIME OF OVERDOSAGE**
- **START UP DELAY**
- **DEFAULT PARAMETER RESTORING**
- **WATER FLOW CONTROL**
- **LEVEL CONTROL**
- **OVER RANGE AND UNDER RANGE OF THE MEASURE**
- **STOP DOSING (STAND_BY)**
- **REAL TIME FLOW RATE %**

DEFAULT SETTINGS

type pH:

- FUNCTIONING: **Prop**
- SETPOINT: **7.2 pH**
- DIRECTION DOSING: **Acid**
- INJECTION FREQUENCY: **100%(150 imp/min)**
- ALARM TIME: **0unit (disabled)**
- START UP DELAY: **0 sec**

type Rx:

- FUNCTIONING: **Prop**
- SETPOINT: **730mV**
- DIRECTION DOSING: **Oxid**
- INJECTION FREQUENCY: **100% (150 imp/min)**
- ALARM TIME: **0unit (disabilitato)**
- START UP DELAY: **0 sec**

DEFAULT SETTINGS RESTORE

<p>Restore Enter</p>	<p>Push and quickly release CAL button and then pressing + and - buttons select “Restore Enter” Push CAL to confirm the choice. The pump goes back in measure restoring in memory the default settings and calibrations parameters.</p>
--	--

PUMP'S CONNECTIONS

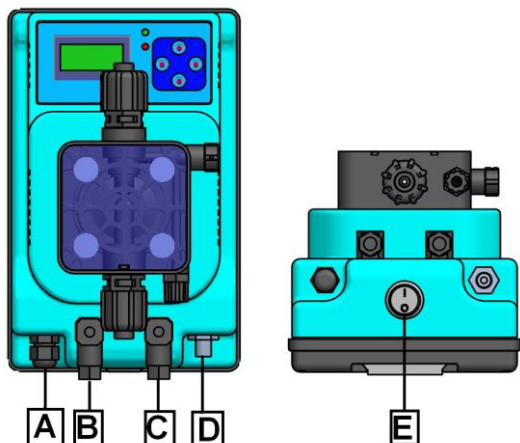

- A** – Power cable, 230 V- 50Hz (upon request : 115 ~)
- B** – Level probe connector (3 and 4 contacts). **OPTIONAL**
- C** – Flow sensor connector (3 and 4 contacts). **OPTIONAL**
- D** - BNC connector for pH or Orp(Rx) probe.
- E** - ON_OFF switch. **OPTIONAL**

STAND BY (STOP)

	<p>Push and hold the ESC/SBY button for 2 seconds during the functioning to put the pump in stand by mode:</p> <ol style="list-style-type: none"> 1) It stops dosing 2) Green on led blinks.
<p>Stop 0% 8.21pH</p>	<p>3) If the functioning is PROPORTIONAL the display shows: “Stop 0%” on the first row and the current measure on the second row (see figure on the left side, the example refers to a pH type)</p>
<p>Stop 50% 8.21pH</p>	<p>3) If the functioning is Manual or ON-OFF the display shows: “Stop” and the % programmed frequency on the first row and the current measure on the second row (see figure on the left side, the example refers to pH type)</p>
<p>Push again the ESC/SBY button for 2 seconds to return the pump to the programmed functioning.</p>	

MENU TREE

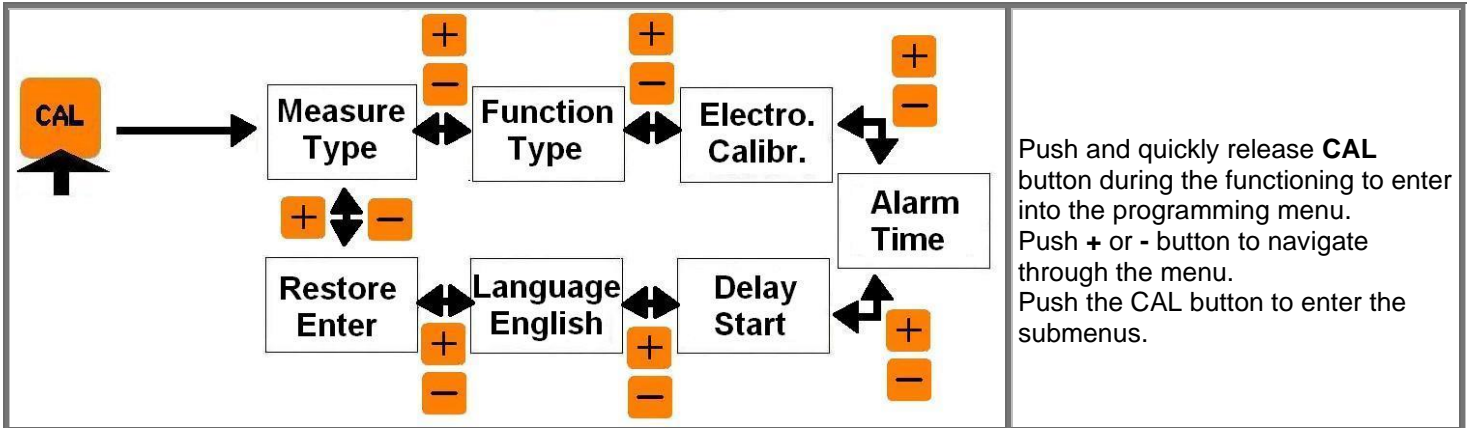

LANGUAGE SELECTION

<p>Language English</p>	<p>Push and quickly release CAL button and then pressing + and - buttons select the language choice. Push CAL to enter the language submenu and select “Language English” by pressing + or - .</p>
<p>Push CAL to confirm the choice and ESC to go back in measuring.</p>	

MEASURE TYPE CHOICE

<p>Measure Type</p> 	<p>Measure pH</p> <p>Measure RX</p>	<p>Push and quickly release CAL button and scroll the menu using + and - buttons till the display shows “Measure Type”. Push CAL to enter the submenu and then by pressing + and - button choice pH or Rx measure. Push CAL to confirm and ESC to go back in measuring.</p>
---	-------------------------------------	--

DELAY START

<p>Delay 7.32pH</p>	<p>WHAT IS IT? The delay start is the time in seconds (0-999sec) after the power on that the pump waits before dosing the chemical product. During this period of time the display shows the message “Delay” on the first row and the measure on the second row (see figure on the left side). During the delay start the pump can't dose but it is possible to enter the menu and modify the parameters and calibrations.</p>
<p>Delay Start</p> 	<p>DELAY START EDITING</p> <p>Push and quickly release CAL button and scroll the menu using + and - buttons till the display shows “Delay Start”. Push CAL to enter the submenu and then by pressing + and - button choice the value in seconds (0-999). Push CAL to confirm and ESC to go back in measuring.</p>

TIME ALARM

<p>Tal 29% 8.21pH</p>	<p>WHAT IS IT? The Time alarm is expressed in units (0-120unit) of dosage. One unit is equivalent to 150 injections of chemical. The injections counting starts from 0 when the pump starts dosing after the power on, increases during dosing, stops during level alarm and stand_by state, and is resetted when the power is off, when the measure reaches the setpoint and during the flow alarm. When the counting reaches the value memorized in Time alarm the pump goes in Time Alarm state:</p>
----------------------------------	---

- 1) The dosing stops (no tension to the electromagnet)
- 2) Green led On blinks
- 3) the display shows: "Tal" and the % flowrate on the first row and the measure on the second row.



Push and hold **ESC** button for 2 seconds to esc the Time Alarm state and to go back to functioning. The time alarm counting restart from 0 when the pump starts dosing again.

Alarm Time



Alarm 0 unit



TIME ALARM EDITING

Push and quickly release **CAL** button and scroll the menu using **+** and **-** buttons till the display shows "Alarm Time". Push **CAL** to enter the submenu and then by pressing **+** and **-** button choice the value in units (0-120). Push **CAL** to confirm and **ESC** to go back in measuring.

MOD	l/h	1 unit	Alarm Time= 2000cc :(unit_cc)
ME3-PH/RX 04/12	4	66.6cc	30 unit
ME3-PH/RX 04/18	4	66.6cc	30 unit
ME3-PH/RX 05/10	5	83.3cc	24 unit
ME3-PH/RX 06/15	6	100cc	20 unit
ME3-PH/RX 10/2	10	166.6cc	12 unit
ME3-PH/RX 26/2	26	433.3cc	5 unit
ME3-PH/RX 30/1	30	500cc	4 unit

Example for the calculation of Alarm Time to dose 2 liters (=2000cc) of chemical at backpressure of the pump nameplate.

NOTE: The time alarm has no effect on Manual mode operation

LEVEL CONTROL



Level
7.32pH

The closing of the level input contact, free of tension, while the pump is working, will cause:

- 1) the dosing stops
- 2) the green ON led blinks
- 3) the display shows "Level" alternatively on the first row and the actual measure on the second row.

When the level contact gets opened again, the pump returns to working mode compatible with the actual inputs. NOTE: The level alarm suspends (but not reset) the counting of the Alarm Time.

FLOW CONTROL



Flow
7.32pH

The closing of the flow input contact, free of tension, will cause:

- 1) the dosing stops
- 2) the green ON led blinks

3) The display shows "Flow" alternatively on the first row and the actual measure on the second row.

When the flow contact gets opened again, the pump returns to working mode compatible with the actual inputs. NOTE: The flow alarm resets the counting of the Alarm Time.

SIGNALS OF O.R and U.R

The display writes OR (Over Range) when the measure exceeds the maximum measurable.

The display writes U.R (Under Range) when the measure falls below the minimum limit measurable.

The green LED on flashes quickly.

If the pump is in Manual Functioning the dosing is not stopped.

If the pump is in the ON-OFF and Proportional Functioning the dosing is stopped.

pH range: 0-14pH

mV range: 0-1000mV

POSSIBLE FUNCTIONING





	<p>There are 3 possible functioning:</p> <p>Function Manual: constant dosing with a number of impulses per minute programmed as follows in the next paragraph.</p> <p>Function Prop: dosing proportional to the distance of the measure from the setpoint. Range of proportionality : 1pH or 100mV</p> <p>Function On-Off: constant dosing that starts when the measure moves away from the setpoint. Total Hysteresis centered on the setpoint: 0.1pH or 10mV</p>
--	---

PROGRAMMING OF MANUAL (CONSTANT) FUNCTIONING AND VISUALIZATION



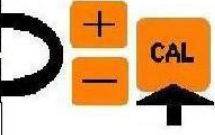

	<p>Push and quickly release CAL button and scroll the menu using + and - buttons till the display shows "Function Type". Push CAL to enter the submenu and then by pressing + and - button choice "Function Manual" and confirm pressing CAL. The display will show "Freq." and the % stored in the last programming. Modify it by pressing + and - button and confirm the choice pressing CAL. Push ESC button to esc the menu and go back in measure with the Manual functioning just programmed.</p> <p>The number of injections of the pump per minute depends on the % programmed. For example: 80% means 120 injections per minute i.e. 150 pulses/min x 0.8 = 120 pulses/min.</p> <p>In Manual functioning the display shows on the first row "Man." and the % frequency programmed. The second row shows the measure.</p>
--	--

PROGRAMMING OF THE FUNCTIONING IN pH TYPE

PROGRAMMING AND VISUALIZATION OF ON-OFF FUNCTIONING IN pH TYPE

<div style="border: 1px solid black; padding: 2px; margin-bottom: 5px;"> Function On-Off </div> 	Push and quickly release CAL button and scroll the menu using + and - buttons till the display shows " Function Type ". Push CAL to enter the submenu and then, by pressing + and - button, choice " Function On-Off " and confirm pressing CAL .
<div style="border: 1px solid black; padding: 2px; margin-bottom: 5px;"> SetPoint 7.00pH </div> 	The display will show the value of setpoint stored in the last programming. Modify it by pressing + and - button and confirm the choice pressing CAL .
<div style="border: 1px solid black; padding: 2px; margin-bottom: 5px;"> SetPoint Acid </div> <div style="border: 1px solid black; padding: 2px; margin-bottom: 5px;"> SetPoint Alk </div> 	The display will show the direction of dosing Acid or Alk stored in the last programming. Choice the direction by + or - button and confirm pressing CAL . Select Acid if you want the pump to inject for pH values greater than Setpoint. Select Alk if you want the pump to inject for values of pH lower than Setpoint.
<div style="border: 1px solid black; padding: 2px; margin-bottom: 5px;"> Freq 100% </div> 	The display will show the % of maximum frequency (150pulses/minute) stored in the last programming. Modify it by pressing + and - button and confirm the choice pressing CAL . Push ESC button to esc the menu and go back in measure with the On-Off functioning just programmed.
<div style="border: 1px solid black; padding: 10px; width: fit-content; margin: 0 auto;"> On 100% 7.11pH </div>	In the On-Off functioning if the pump is dosing the display shows " On " and the % frequency programmed on the first row, if the pump doesn't dose the display shows " Off " and the % frequency programmed. On the second row the display writes the measure.

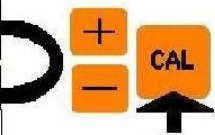
PROGRAMMING AND VISUALIZATION OF PROPORTIONAL FUNCTIONING IN pH TYPE

<div style="border: 1px solid black; padding: 2px; margin-bottom: 5px;"> Function Prop </div> 	Range of proportionality = 1pH Push and quickly release CAL button and scroll the menu using + and - buttons till the display shows " Function Type ". Push CAL to enter the submenu and then, by pressing + and - button, choice " Function Prop " and confirm pressing CAL .
<div style="border: 1px solid black; padding: 2px; margin-bottom: 5px;"> SetPoint 7.00pH </div> 	The display will show the value of setpoint stored in the last programming. Modify it by pressing + and - button and confirm the choice pressing CAL .
<div style="border: 1px solid black; padding: 2px; margin-bottom: 5px;"> SetPoint Acid </div> <div style="border: 1px solid black; padding: 2px; margin-bottom: 5px;"> SetPoint Alk </div> 	The display will show the direction of dosing Acid or Alk stored in the last programming. Choice the direction by + or - button and confirm pressing CAL . Select Acid if you want the pump to inject for pH values greater than Setpoint. Select Alk if you want the pump to inject for values of pH lower than Setpoint.
<div style="border: 1px solid black; padding: 2px; margin-bottom: 5px;"> Freq 100% </div> 	The display will show the % of maximum frequency (150pulses/minute) stored in the last programming. Modify it by pressing + and - button and confirm the choice pressing CAL . Push ESC button to esc the menu and go back in measure with the Proportional functioning just programmed.
<div style="border: 1px solid black; padding: 10px; width: fit-content; margin: 0 auto;"> Prop 100% 7.11pH </div>	In the Proportional functioning the display shows on the first row " Prop " and the actual % frequency of dosing that the pump is doing respect to the % frequency programmed. On the second row the display writes the measure.



During the programming if you do not push any button (+, -, CAL) for more than 60 seconds, the pump will get out of programming keeping the data stored until that moment.

pH PROBE CALIBRATION

Attention,

Be sure that the buffer solution used in calibration matches always the indicated value, and that they're not polluted.

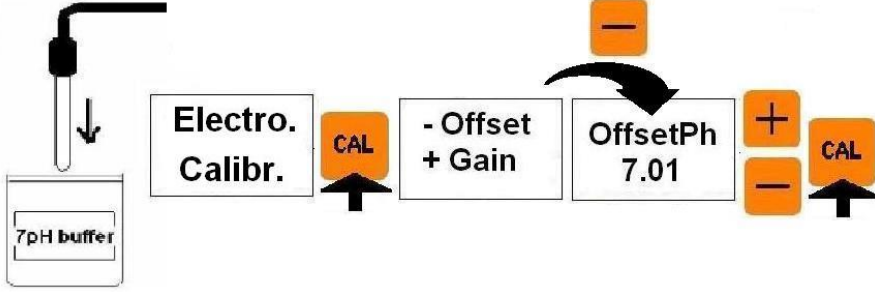
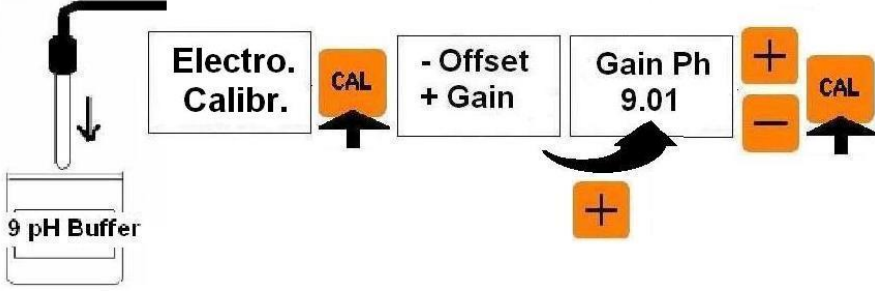
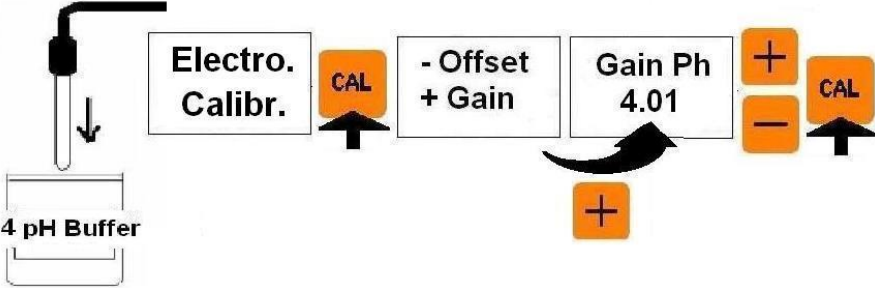

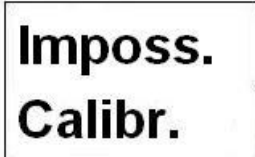

<p>BUFFER 7.01pH</p> 	<p>OFFSET CALIBRATION</p> <p>Dip the probe in the pH7 buffer solution and wait for the stabilization of the measure on the display. Push and quickly release CAL button and then scroll the menu till the display shows “Electro. Calibr.” Push CAL to enter the submenu and then the button - to do the OFFSET calibration of the probe. If it is necessary you can modify the value of the buffer solution shown in the second row of the display by buttons + or -. Push CAL to confirm. If the display shows the message “Imposs. Calibr.” the probe calibration is not saved. Read the following paragraph named “MESSAGES FROM THE PUMP”. If no error message appears the calibration has been performed.</p>
<p>BUFFER 9.01pH</p> 	<p>GAIN CALIBRATION</p> <p>Wash the probe with water and then dip it in 9 pH or 4 pH buffer solution. Wait for stabilization of the measure on the display. Push and quickly release CAL button and then scroll the menu till the display shows “Electro. Calibr.” Push CAL to enter the submenu and then the button + to do the GAIN calibration of the probe. If it is necessary you can modify the value of the buffer solution shown in the second row of the display by buttons + or -. Push CAL to confirm. If the display shows the message “Imposs. Calibr.” the probe calibration is not saved. Read the following paragraph named “MESSAGES FROM THE PUMP”. If no error message appears the calibration has been performed.</p>
<p>BUFFER 4.01pH</p> 	<p>GAIN CALIBRATION</p> <p>Wash the probe with water and then dip it in 9 pH or 4 pH buffer solution. Wait for stabilization of the measure on the display. Push and quickly release CAL button and then scroll the menu till the display shows “Electro. Calibr.” Push CAL to enter the submenu and then the button + to do the GAIN calibration of the probe. If it is necessary you can modify the value of the buffer solution shown in the second row of the display by buttons + or -. Push CAL to confirm. If the display shows the message “Imposs. Calibr.” the probe calibration is not saved. Read the following paragraph named “MESSAGES FROM THE PUMP”. If no error message appears the calibration has been performed.</p>

MESSAGES FROM THE PUMP

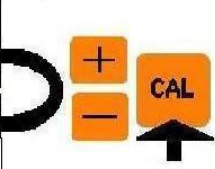

	<p>THIS MESSAGE MEANS THAT THE CALIBRATION IS IMPOSSIBLE AND HAS TO BE DONE AGAIN.</p> <p>If after the calibration repetition the display shows again this message:</p> <ol style="list-style-type: none"> Check that the buffer solution is not polluted (eventually replace it). Check that the buffer solution selected on the display during the calibration is the value of the one really used. The pH probe could not be working well (replace it)
--	---

PROGRAMMING OF THE FUNCTIONING IN Rx (mV)TYPE

PROGRAMMING AND VISUALIZATION OF ON-OFF FUNCTIONING IN Rx (mV) TYPE

<div style="border: 1px solid black; padding: 2px; margin-bottom: 5px;"> Function On-Off </div> 	<p>Push and quickly release CAL button and scroll the menu using + and - buttons till the display shows "Function Type". Push CAL to enter the submenu and then, by pressing + and - button, choice "Function On-Off" and confirm pressing CAL.</p>
<div style="border: 1px solid black; padding: 2px; margin-bottom: 5px;"> SetPoint 700mV </div> 	<p>The display will show the value of setpoint stored in the last programming. Modify it by pressing + and - button and confirm the choice pressing CAL.</p>
<div style="border: 1px solid black; padding: 2px; margin-bottom: 5px;"> SetPoint Oxid </div> <div style="border: 1px solid black; padding: 2px; margin-bottom: 5px;"> SetPoint Red </div> 	<p>The display will show the direction of dosing Oxid or Red stored in the last programming. Choice the direction by + or - button and confirm pressing CAL.</p> <p>Select Red if you want the pump to inject for mV values greater than Setpoint. Select Oxid if you want the pump to inject for values of mV lower than Setpoint.</p>
<div style="border: 1px solid black; padding: 2px; margin-bottom: 5px;"> Freq 100% </div> 	<p>The display will show the % of maximum frequency (150pulses/minute) stored in the last programming. Modify it by pressing + and - button and confirm the choice pressing CAL. Push ESC button to esc the menu and go back in measure with the On-Off functioning just programmed.</p>
<div style="border: 1px solid black; padding: 5px; width: fit-content; margin: 0 auto;"> On 100% 510mV </div>	<p>In the On-Off functioning if the pump is dosing the display shows "On" and the % frequency programmed on the first row, if the pump doesn't dose the display shows "Off" and the % frequency programmed. On the second row the display writes the measure.</p>

PROGRAMMING AND VISUALIZATION OF PROPORTIONAL FUNCTIONING IN Rx (mV) TYPE

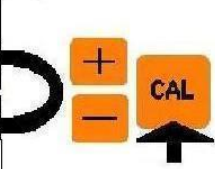
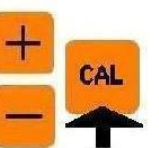
<div style="border: 1px solid black; padding: 2px; margin-bottom: 5px;"> Function Prop </div> 	<p>Range of proportionality = 100mV</p> <p>Push and quickly release CAL button and scroll the menu using + and - buttons till the display shows "Function Type". Push CAL to enter the submenu and then, by pressing + and - button, choice "Function Prop" and confirm pressing CAL.</p>
<div style="border: 1px solid black; padding: 2px; margin-bottom: 5px;"> SetPoint 700mV </div> 	<p>The display will show the value of setpoint stored in the last programming. Modify it by pressing + and - button and confirm the choice pressing CAL.</p>
<div style="border: 1px solid black; padding: 2px; margin-bottom: 5px;"> SetPoint Oxid </div> <div style="border: 1px solid black; padding: 2px; margin-bottom: 5px;"> SetPoint Red </div> 	<p>The display will show the direction of dosing Oxid or Red stored in the last programming. Choice the direction by + or - button and confirm pressing CAL.</p> <p>Select Red if you want the pump to inject for mV values greater than Setpoint. Select Oxid if you want the pump to inject for values of mV lower than Setpoint.</p>
<div style="border: 1px solid black; padding: 2px; margin-bottom: 5px;"> Freq 100% </div> 	<p>The display will show the % of maximum frequency (150pulses/minute) stored in the last programming. Modify it by pressing + and - button and confirm the choice pressing CAL. Push ESC button to esc the menu and go back in measure with the Proportional functioning just programmed.</p>
<div style="border: 1px solid black; padding: 5px; width: fit-content; margin: 0 auto;"> Prop100% 500mV </div>	<p>In the Proportional functioning the display shows on the first row "Prop" and the actual % frequency of dosing that the pump is doing respect to the % frequency programmed. On the second row the display writes the measure.</p>



During the programming if you do not push any button (+, -, **CAL**) for more than 60 seconds, the pump will get out of programming keeping the data stored until that moment.

Rx (mV) PROBE CALIBRATION

Attention,

Be sure that the buffer solution used in calibration matches always the indicated value, and that they're not polluted.

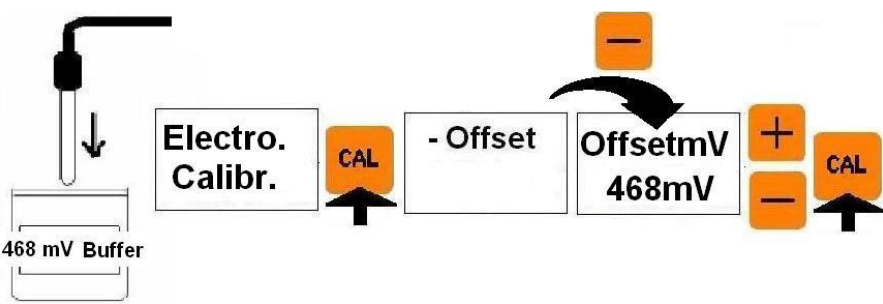
<p>BUFFER 468mV</p>  <p>The diagram illustrates the calibration steps: 1. Dip the probe into a 468 mV Buffer. 2. The display shows 'Electro. Calibr.' and a 'CAL' button is pressed. 3. The display shows '- Offset'. 4. A '-' button is pressed to enter the 'OffsetmV 468mV' menu. 5. '+' or '-' buttons are used to adjust the value. 6. A 'CAL' button is pressed to confirm the calibration.</p>	<p>OFFSET CALIBRATION</p> <p>Dip the probe in the 468mV buffer solution and wait for the stabilization of the measure on the display. Push and quickly release CAL button and then scroll the menu till the display shows "Electro. Calibr." Push CAL to enter the submenu and then the button - to do the OFFSET calibration of the probe. If it is necessary you can modify the value of the buffer solution shown in the second row of the display by buttons + or -. Push CAL to confirm.</p> <p>If the display shows the message "Imposs. Calibr." the probe calibration is not saved. Read the following paragraph named "MESSAGES FROM THE PUMP". If no error message appears the calibration has been performed.</p>
--	---

MESSAGES FROM THE PUMP

 <p>Imposs. Calibr.</p>	<p>THIS MESSAGE MEANS THAT THE CALIBRATION IS IMPOSSIBLE AND HAS TO BE DONE AGAIN.</p> <p>If after the calibration repetition the display shows again this message:</p> <ol style="list-style-type: none">Check that the buffer solution is not polluted (eventually replace it).Check that the buffer solution selected on the display during the calibration is the value of the one really used.The pH probe could not be working well (replace it)
---	---

DESCRIPTION DE LA FACE AVANT

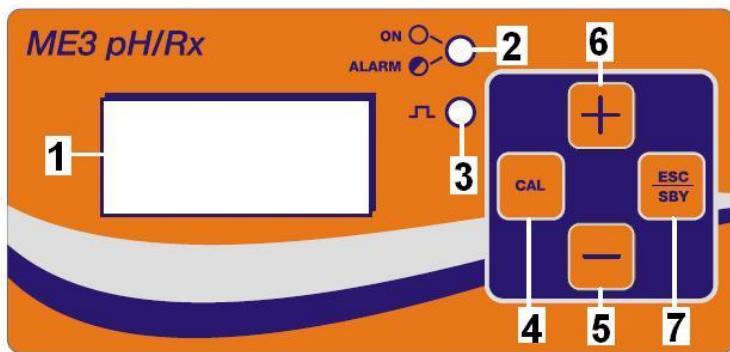

1. **Afficheur** à LCD 8 x 2 rétro-éclairé
2. **Led verte**:
 - allumé fixe = POMPE EN MARCHÉ
 - Clignotant = ÉTAT D'ALARME
3. **Led rouge**: indique les injections
4. Touche **CAL**:
 - pour accéder à la programmation
 - pour confirmer le choix
- 5/6. Touche **- e +**:
 - pour naviguer dans le menu
 - Modifiez la valeur des paramètres
7. Touche **ESC/SBY**:
 - met la pompe en stand-by
 - pour quitter le menu

CARACTÉRISTIQUES GÉNÉRALES DE LA POMPE:

- MENU EN 4 LANGUES : ITALIEN, ANGLAIS, FRANÇAIS, ESPAGNOL
- CHOIX DE **CONTRÔLE DE pH ou mV (Rx)** DE PROGRAMME
- 3 TYPES POSSIBLES DE FONCTIONNEMENT: **CONSTANT, ON / OFF, PROPORTIONNELLE**
- **ALARME DE SURDOSAGE**
- **DÉMARRAGE TARDIF**
- **RETABLISSEMENT DES PARAMETRES DE DÉFAUT**
- **CONTRÔLE DES FLUX DE L'EAU**
- **CONTRÔLE DE NIVEAU**
- SIGNAL DE **OVER RANGE** ET **UNDER RANGE** DE MESURE
- STOP DE DOSAGE (**STAND_BY**)
- **AFFICHAGE DE DÉBIT % MOMENT INSTANT POUR INSTANT**

REGLAGE D'USINE

type pH:

- POINT DE CONSIGNE: **7.2 pH**
- DOSAGE DIRECTION: **Acid**
- FRÉQUENCE D'INJECTIONS À LA MINUTE: **100% (150 imp/min)**
- TEMPS D'ALARME: **0unit (désactivé)**
- RETARD DE ALLUMAGE: **0 sec**

type (mV) Rx:

- OPÉRATION: **Prop**
- POINT DE CONSIGNE: **730mV**
- DOSAGE DIRECTION: **Oxid**
- FRÉQUENCE D'INJECTIONS À LA MINUTE: **100% (150 imp/min)**
- TEMPS D'ALARME: **0unit (désactivé)**
- RETARD DE ALLUMAGE: **0 sec**

RETABLISSEMENT DE RÉGLAGE D'USINE

Rem.Init
Enter



Pressez et relâchez rapidement la touche CAL puis le boutons + et - jusqu'à ce que apparaît l'inscription «Rem. Init. Enter». Appuyez sur CAL pour confirmer. La pompe revient automatiquement à mesurer avec les valeurs de programmation de la mémoire et l'étalonnage d'usine.

CONNEXIONS DE LA POMPE

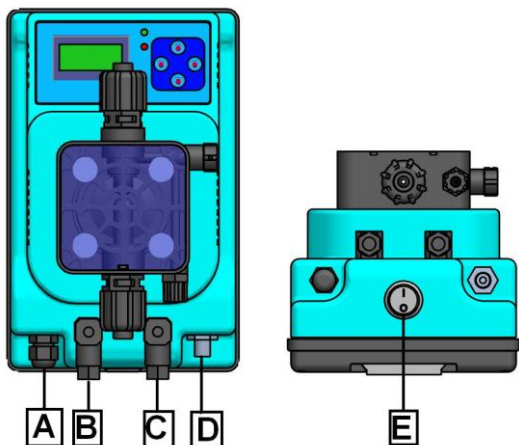

- A** - Alimentation électrique, 230V-50 Hz (sur demande : 115 ~)
- B** - Connecteur de la sonde de niveau (contacts 3 et 4). OPTION
- C** - Connecteur du capteur de flux (contacts 3 et 4). OPTION
- D** - Connecteur BNC de la sonde du pH ou Orp (Rx).
- E** - Interrupteur ON_OFF. OPTION

STAND BY (STOP)

	<p>La pression prolongée de 2 secondes de la touche ESC/SBY pendant le fonctionnement met la pompe en état de stand by:</p> <ol style="list-style-type: none"> 1) CESTE LE DOSAGE 2) LED vert de ON clignotant
<p>Stop 0% 8.21pH</p>	<p>3) Dans le fonctionnement Proportionnel l'affichage indique: "Stop 0%" sur la première ligne et la mesure réelle sur la deuxième ligne (voir la figure à côté, se réfère à type pH)</p>
<p>Stop 50% 8.21pH</p>	<p>3) Dans le fonctionnement Manuel et ON-OFF, l'affichage indique: "Stop" et le % de la fréquence programmée sur la première ligne et la mesure réelle sur la deuxième ligne (voir figure à droite). La nouvelle pression de la touche ESC / SBY de 2 secondes fait revenir la pompe dans l'état de fonctionnement initial</p>

STRUCTURE DU MENU

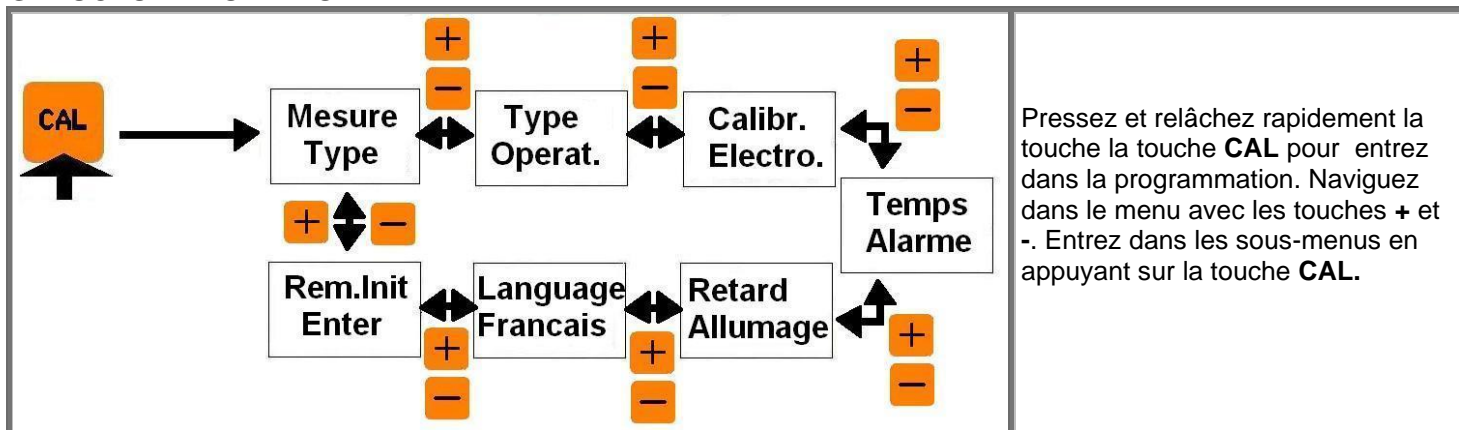

CHOIX DE LA LANGUE

<p>Language Francais</p>	<p>Pressez et relâchez rapidement la touche CAL et défilez le menu avec les boutons + et - jusqu'à ce que apparaît l'inscription de le choix de la langue. Appuyez sur la touche CAL et avec le boutons + et - choisir: Language Français. Appuyer sur CAL pour confirmer et ESC pour revenir à la mesure</p>
---------------------------------	---

CHOIX DU TYPE DE MESURE

<p>Mesure Type</p>  <p>Mesure pH</p> <p>Mesure RX</p>	<p>Pressez et relâchez rapidement la touche CAL et défilez le menu avec les boutons + et - jusqu'à ce que apparaît l'inscription "Mesure Type". Appuyez sur la touche CAL et avec le boutons + et - choisir pH ou Rx. Appuyez sur CAL pour confirmer et ESC pour revenir à la mesure</p>
--	--

RETARD D'ALLUMAGE

<p>Retard 7.32pH</p>	<p>Qu'est-ce que c'est? Le Retard d'Allumage est le temps en secondes (0-999sec) que la pompe attend après l'allumage avant le dosage du produit chimique. Pendant ce temps apparaît l'inscription "Retard" sur la première ligne de l'affichage et la mesure sur la deuxième ligne. (Voir figure). Pendant ce temps, la pompe ne peut pas doser mais vous pouvez accéder au menu pour modifier les paramètres et les étalonnages.</p>
<p>Retard Allumage</p>  <p>Retard 0 sec.</p>	<p>MODIFICATION DU RETARD D' ALLUMAGE Pressez et relâchez rapidement la touche CAL et faire défiler le menu avec les touches + et - jusqu'à ce que apparaît l'inscription "Retard Allumage". Appuyer sur CAL pour entrer et avec les touches + et - choisir le retard à partir de 0 à 999 secondes. Appuyez sur CAL pour confirmer et ESC pour revenir à la mesure.</p>

ALARME À TEMPS

<p>Tal 29% 8.21pH</p>	<p>Qu'est-ce que c'est? Le temps d'alarme est exprimée en unit (unités) de dosage. 1 Unité de dosage est équivalent à 150 injections de produits chimiques. Le comptage de ces injections commence à 0 à partir du moment où la pompe commence le dosage après l'allumage, il est incrémenté au cours du traitement, il est suspendue pendant l'alarme de niveau et au cours de l'état de stand_by, est remis à zéro si l'alimentation électrique est coupée, si la mesure atteint le point de consigne et au cours de l'alarme de flux d'eau.</p>
----------------------------------	--

Lorsque le comptage rejoint la valeur mémorisée dans Temps Alarme, la pompe entre en état d'alarme temporal :

- 1) LE DOSAGE CESSE (aucune tension du aimant)
- 2) LED vert de ON clignotant
- 3) LE DISPLAY visualise : "Tal "et la % du débit sur la première ligne et la mesure sur la deuxième ligne. (Voir figure).



La pression prolongée de la touche **ESC** de 2 secondes remet la pompe en marche et remet à zéro le comptage qui repart immédiatement quand la pompe recommence à doser.

Temps
Alarme



Temps
0 unit



MODIFICATION DU TEMPS D'ALARME

Pressez et relâchez rapidement la touche **CAL** et faire défiler le menu avec les touches **+** et **-** jusqu'à ce que apparaît l'inscription "Temps Alarme". Appuyer sur **CAL** pour entrer et avec les touches **+** et **-** choisir le Temps à partir de 0 à 120 unités. Appuyez sur **CAL** pour confirmer et **ESC** pour revenir à la mesure.

MOD	l/h	1 unit	Temps Alarme= 2000cc :(unit_cc)
ME3-PH/RX 04/12	4	66.6cc	30 unit
ME3-PH/RX 04/18	4	66.6cc	30 unit
ME3-PH/RX 05/10	5	83.3cc	24 unit
ME3-PH/RX 06/15	6	100cc	20 unit
ME3-PH/RX 10/2	10	166.6cc	12 unit
ME3-PH/RX 26/2	26	433.3cc	5 unit
ME3-PH/RX 30/1	30	500cc	4 unit

EXEMPLE de calcul du Temps d'Alarme si l'on veut injecter 2 litres (=2000cc) de produits chimiques à la pression de la plaque signalétique de la pompe.

REMARQUE : Le Temps d'Alarme n'a aucun effet sur le type de Opération Manuel

CONTRÔLE DU FIN NIVEAU (OPTION)



Niveau
7.32pH

La fermeture du contact de niveau, libre de tension, pendant le fonctionnement de la pompe, dans n'importe laquelle modalité elle se trouve, provoque:

- 1) la cessation de l'activité de dosage
- 2) l'allumage clignotant du led vert on.
- 3) le display visualise l'inscription "**NIVEAU**" sur la première ligne et la mesure réelle sur la deuxième ligne (voir la figure à coté).

La rentrée du contact de niveau fait revenir la pompe dans l'état de FONCTIONNEMENT congruent avec les entrées actuelles de la pompe. NOTE:l'alarme de niveau provoque la suspension (mais pas réinitialisation) du comptage d'alarme de surdosage.

CONTRÔLE DU FLUX D'EAU (OPTION)



Flux
7.32pH

La fermeture du contact de flux, libre de tension, pendant le fonctionnement de la pompe, dans n'importe laquelle modalité elle se trouve, provoque:

- 1) la cessation de l'activité de dosage
- 2) l'allumage clignotant du led vert on.
- 3) le display visualise l'inscription "**Flux**" sur la première ligne et la mesure réelle sur la deuxième ligne (voir la figure à coté).

La rentrée du contact de niveau fait revenir la pompe dans l'état de FONCTIONNEMENT congruent avec les entrées actuelles de la pompe.

NOTE:l'alarme de flux provoque la remis à zéro du comptage d'alarme de surdosage.

SIGNAUX O.R. et U.R.

Le display de la pompe indique O.R. (Over Range) quand la mesure supère le limite maximal mesurable.

Le display de la pompe indique U.R. (Under Range) quand la mesure descend au dessous de la limite minimum mesurable.

Le led verte « on » s'allume rapidement.

Si la pompe est en fonction Manuelle le dosage ne s'arrête pas.

Si la pompe est en fonction ON-OFF et Proportionnelle, le dosage est arrêté.

pH range: 0-14pH

mV range: 0-1000mV

FONCTIONNEMENT POSSIBLES

	Type Manual	+	<p>Il y a 3 modes possibles:</p> <p>Manuel: dosage constant. Le nombre d'impulsions par minute est défini dans la programmation comme est expliqué dans la section suivante.</p> <p>Proportionnel: dosage proportionnel à la distance de mesure du point de consigne désirée. Gamme de proportionnalité: 1pH ou 100mV</p> <p>ON-OFF: dosage de type constante qui est activée lorsque la mesure s'éloigne de la valeur de consigne. Hystérésis centrée sur le point de consigne: 0.1pH ou 10mV</p>
	Type Prop	-	
	Type On-Off	-	





PROGRAMMATION MANUELLE (CONSTANTE) ET AFFICHAGE

	<p>Pressez et relâchez rapidement la touche CAL et faire défiler le menu avec les touches + et - jusqu'à ce que apparaît l'inscription "Type de Operat.". Appuyer sur CAL pour entrer et avec les touches + et - choisir "Type Manual" et confirmer avec CAL. Apparaît l'inscription "Freq." et la valeur % précédemment mémorisée. Réglez avec + et - cette valeur et confirmez la sélection avec CAL. Appuyez sur ESC pour sortir de la programmation et revenir à la mesure avec le fonctionnement Manuel programmée.</p>



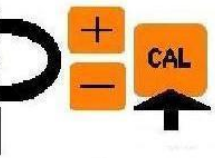

Man.100%
7.11pH

PROGRAMMATION DU TYPE D' OPÉRATION DANS pH

PROGRAMMATION DU FONCTIONNEMENT ON-OFF pH ET VISUALISATION

<p>Type On-Off</p> 	<p>Pressez et relâchez rapidement la touche CAL et faire défiler le menu avec les touches + et - jusqu'à ce que apparait l'inscription "Type de Operat.". Appuyer sur CAL pour entrer et avec les touches + et - choisir "Type On-Off" et confirmer avec CAL.</p>
<p>SetPoint 7.00pH</p> 	<p>Apparaît l'inscription "SetPoint" et la valeur du point de consigne précédemment mémorisée. Réglez avec + et - cette valeur et confirmez la sélection avec CAL.</p>
<p>SetPoint Acid</p> <p>SetPoint Alk</p> 	<p>Apparaît l'inscription "SetPoint Acid" ou "SetPoint Alk" précédemment mémorisée. Choisir avec + et - cette valeur et confirmez la sélection avec CAL.</p>
<p>Freq 100%</p> 	<p>Apparaît l'inscription "Freq." et la valeur % de la fréquence maximale d'injection (150 imp / min) précédemment mémorisée. Réglez avec + et - cette valeur et confirmez la sélection avec CAL. Appuyez sur ESC pour sortir de la programmation et revenir à la mesure avec le fonctionnement On-Off programmée.</p>
<p>On 100%</p> <p>7.11pH</p>	<p>Pendant le fonctionnement On-Off si la pompe est en dosage l'affichage écrit sur la première ligne "On" et la % de la fréquence d'injection programmée. Si la pompe n'est pas en dosage l'affichage écrit sur la première ligne "Off" et le pourcentage de la fréquence d'injection programmée. La deuxième ligne montre la mesure.</p>

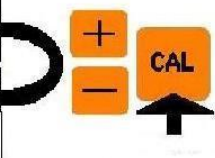
PROGRAMMATION DU FONCTIONNEMENT PROPORTIONNEL AU pH ET VISUALISATION

<p>Type Prop</p> 	<p>Gamme de proportionnalité=1pH</p>
<p>SetPoint 7.00pH</p> 	<p>Pressez et relâchez rapidement la touche CAL et faire défiler le menu avec les touches + et - jusqu'à ce que apparait l'inscription "Type de Operat.". Appuyer sur CAL pour entrer et avec les touches + et - choisir "Type Prop" et confirmer avec CAL.</p>
<p>SetPoint Acid</p> <p>SetPoint Alk</p> 	<p>Apparaît l'inscription "SetPoint" et la valeur du point de consigne précédemment mémorisée. Réglez avec + et - cette valeur et confirmez la sélection avec CAL.</p>
<p>Freq 100%</p> 	<p>Apparaît l'inscription "SetPoint Acid" ou "SetPoint Alk" précédemment mémorisée. Choisir avec + et - cette valeur et confirmez la sélection avec CAL.</p>
<p>Prop 100%</p> <p>7.11pH</p>	<p>Choisir Acid si vous voulez de dosage pour valeurs de pH au-dessus du point de consigne. Choisir Alk si vous voulez de dosage pour des valeurs de pH dessous du point de consigne.</p>
	<p>Apparaît l'inscription "Freq." et la valeur % de la fréquence maximale d'injection (150 imp / min) précédemment mémorisée. Réglez avec + et - cette valeur et confirmez la sélection avec CAL. Appuyez sur ESC pour sortir de la programmation revenir à la mesure avec le fonctionnement On-Off programmée.</p>
	<p>Pendant le fonctionnement Proportionnelle l'affichage écrit sur la première ligne "Prop" et la % de la fréquence d'injections que l'aimant fait par rapport à la fréquence des injections programmée.</p>
	<p>La deuxième ligne montre la mesure.</p>



En n'importe quel point de réglage du setpoint si aucune touche n'est pressée (+, -, CAL) pendant 60 secondes, la pompe sort du réglage avec les nouveaux paramètres jusqu'à ce moment mémorisés

CALIBRAGE D' ELECTRODE DE pH

Attention,

Être sûr que la solution tampon utilisée pour le calibrage, correspond toujours à la valeur indiquée, et qu'elle n'est pas pollués.

<p>BUFFER 7.01pH</p>	<p>CALIBRAGE DE L'OFFSET</p> <p>Insérer la sonde de pH dans la solution tampon pH 7. Attendez pour stabiliser la lecture sur l'affichage.</p> <p>Pressez et relâchez rapidement la touche CAL et faire défiler le menu avec les touches + et - jusqu'à ce que apparaît l'inscription "Calibr.Electro.". Appuyer sur CAL pour entrer et appuyer sur la touche - pour calibrer le Offset de la sonde. Ajustez (si nécessaire) la valeur de la lecture de la solution tampon avec les touches + et - , puis confirmez avec CAL. Si le message "Calibr. Imposib." apparaît, l'étalonnage n'a pas été fait. Lisez le paragraphe suivant: MESSAGES DE LA POMPE.</p> <p>Si aucun message d'erreur apparaît le calibrage a été effectué.</p>
<p>BUFFER 9.01pH</p> <p>BUFFER 4.01pH</p>	<p>CALIBRAGE DU GAIN</p> <p>Nettoyer la sonde avec de l'eau et insérer la sonde de pH dans la solution tampon pH 9 ou 4. Attendez pour stabiliser la lecture sur l'affichage.</p> <p>Pressez et relâchez rapidement la touche CAL et faire défiler le menu avec les touches + et - jusqu'à ce que apparaît l'inscription "Calibr.Electro.". Appuyez sur CAL pour entrer et appuyez sur la touche + pour calibrer le GAIN de la sonde. Ajuster (si nécessaire) la valeur de la lecture de la solution tampon avec les touches + et - , puis confirmer avec CAL. Si le message "Calibr. Imposib." apparaît, l'étalonnage n'a pas été fait. Lisez le paragraphe suivant: MESSAGES DE LA POMPE.</p> <p>Si aucun message d'erreur apparaît le calibrage a été effectué</p>

MESSAGES DE LA POMPE





<p>Calibr. Imposib.</p>	<p>INDIQUE QUE LE CALIBRAGE DE LA SONDE EST IMPOSSIBLE. IL EST NECESSAIRE DE RÉPÉTER LE CALIBRAGE.</p> <p>Si après avoir répété le calibrage le message apparaît de nouveau:</p> <ol style="list-style-type: none">Contrôler que la solution tampon ne soit pas polluée, éventuellement la remplacer.Contrôler que la solution tampon choisi sur le display pendant le calibrage soit effectivement celle utilisée.la sonde pourrait être usée (la remplacer).
--------------------------------	---

PROGRAMMATION DE TYPE D' OPÉRATION DANS Rx (mV)

PROGRAMMATION DU FONCTIONNEMENT ON-OFF Rx ET VISUALISATION

<p>Type On-Off</p> 	<p>Pressez et relâchez rapidement la touche CAL et faire défiler le menu avec les touches + et - jusqu'à ce que apparaît l'inscription "Type de Operat.". Appuyer sur CAL pour entrer et avec les touches + et - choisir "Type On-Off" et confirmer avec CAL.</p>
<p>SetPoint 700mV</p> 	<p>Apparaît l'inscription "SetPoint" et la valeur du point de consigne précédemment mémorisée. Réglez avec + et - cette valeur et confirmez la sélection avec CAL.</p>
<p>SetPoint Oxid</p> 	<p>Apparaît l'inscription "SetPoint Oxid" ou "SetPoint Red" précédemment mémorisée. Choisir avec + et - cette valeur et confirmez la sélection avec CAL.</p>
<p>SetPoint Red</p> 	<p>Choisir Red si vous voulez de dosage pour valeurs de mV au-dessus du point de consigne. Choisir Oxid si vous voulez de dosage pour des valeurs de mV dessous du point de consigne.</p>
<p>Freq 100%</p> 	<p>Apparaît l'inscription "Freq." et la valeur % de la fréquence maximale d'injection (150 imp / min) précédemment mémorisée. Réglez avec + et - cette valeur et confirmez la sélection avec CAL. Appuyez sur ESC pour sortir de la programmation et revenir à la mesure avec le fonctionnement On-Off programmée.</p>
<p>On 100% 510mV</p>	<p>Pendant le fonctionnement On-Off si la pompe est en dosage l'affichage écrit sur la première ligne "On" et la % de la fréquence d'injection programmée. Si la pompe n'est pas en dosage l'affichage écrit sur la première ligne "Off" et le pourcentage de la fréquence d'injection programmée. La deuxième ligne montre la mesure.</p>

PROGRAMMATION DU FONCTIONNEMENT PROPORTIONNEL AU mV (Rx) ET VISUALISATION

<p>Type Prop</p> 	<p>Gamme de proportionnalité=100mV</p> <p>Pressez et relâchez rapidement la touche CAL et faire défiler le menu avec les touches + et - jusqu'à ce que apparaît l'inscription "Type de Operat.". Appuyer sur CAL pour entrer et avec les touches + et - choisir "Type Prop" et confirmer avec CAL.</p>
<p>SetPoint 700mV</p> 	<p>Apparaît l'inscription "SetPoint" et la valeur du point de consigne précédemment mémorisée. Réglez avec + et - cette valeur et confirmez la sélection avec CAL.</p>
<p>SetPoint Oxid</p> 	<p>Apparaît l'inscription "SetPoint Red" ou "SetPoint Oxid" précédemment mémorisée. Choisir avec + et - cette valeur et confirmez la sélection avec CAL.</p>
<p>SetPoint Red</p> 	<p>Choisir Red si vous voulez de dosage pour valeurs de pH au-dessus du point de consigne. Choisir Oxid si vous voulez de dosage pour des valeurs de pH dessous du point de consigne.</p>
<p>Freq 100%</p> 	<p>Apparaît l'inscription "Freq." et la valeur % de la fréquence maximale d'injection (150 imp / min) précédemment mémorisée. Réglez avec + et - cette valeur et confirmez la sélection avec CAL. Appuyez sur ESC pour sortir de la programmation et revenir à la mesure avec le fonctionnement On-Off programmée.</p>
<p>Prop 100% 500mV</p>	<p>Pendant le fonctionnement Proportionnelle l'affichage écrit sur la première ligne "Prop" et la % de la fréquence d'injections que l'aimant fait par rapport à la fréquence des injections programmée. La deuxième ligne montre la mesure.</p>



En n'importe quel point de réglage du setpoint si aucune touche n'est pressée (+, -, **CAL**) pendant 60 secondes, la pompe sort du réglage avec les nouveaux paramètres jusqu'à ce moment mémorisés

CALIBRAGE D'ELECTRODE DE mV (Rx)

Attention, Être sûr que la solution tampon utilisée pour le calibrage, correspond toujours à la valeur indiquée, et qu'ils n'est pas pollués.

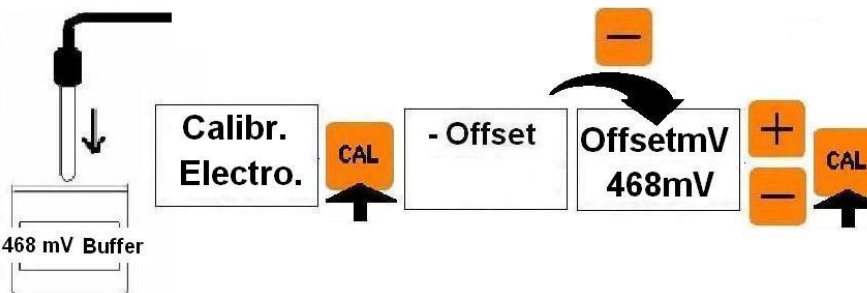
<p>BUFFER 468mV</p>  <p>Calibr. Electro. CAL - Offset OffsetmV 468mV + - CAL</p>	<p>CALIBRAGE DE L'OFFSET</p> <p>Insérer la sonde de mV (RX) dans la solution tampon au 468mV. Attendez pour stabiliser la lecture sur l'affichage. Pressez et relâchez rapidement la touche CAL et faire défiler le menu avec les touches + et - jusqu'à ce que apparaît l'inscription "Calibr.Electro.". Appuyer sur CAL pour entrer et appuyer sur la touche - pour calibrer le Offset de la sonde. Ajuster (si nécessaire) la valeur de la lecture de la solution tampon avec les touches + et -, puis confirmer avec CAL. Si le message "Calibr. Imposib." apparaît, l'étalonnage n'a pas été fait. Lisez le paragraphe suivant: MESSAGES DE LA POMPE. Si aucun message d'erreur apparaît le calibrage a été effectué.</p>
---	--

MESSAGES DE LA POMPE

<p>Calibr. Imposib.</p>	<p>INDIQUE QUE LE CALIBRAGE DE LA SONDE EST IMPOSSIBLE. IL EST NECESSAIRE DE RÉPÉTER LE CALIBRAGE.</p> <p>Si après avoir répété le calibrage le message apparaît de nouveau:</p> <ol style="list-style-type: none">Contrôler que la solution tampon ne soit pas polluée, éventuellement la remplacer.Contrôler que la solution tampon choisi sur le display pendant le calibrage soit effectivement celle utilisée.la sonde pourrait être usée (la remplacer).
--------------------------------	---

DESCRIPCIÓN DEL PANEL FRONTAL

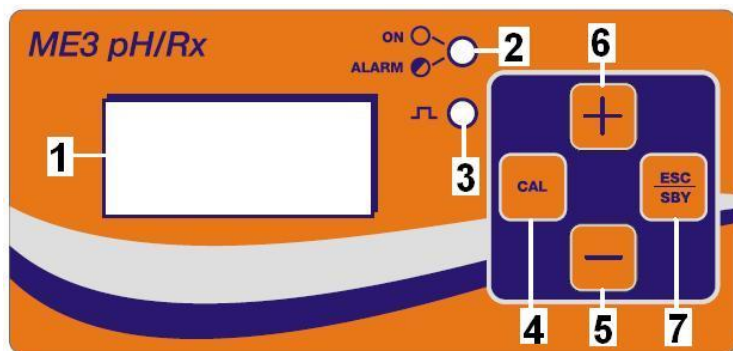

1. Display LCD 8 x 2 con luz de fondo
2. Led **verde**:
 - fijo = BOMBA EN ON
 - intermitente= BOMBA EN ALARMA
3. Led **rojo**: señala las inyecciones
4. Tecla **CAL**:
 - para entrar en la programación
 - Para salvar los cambios
- 5/6. Tecla **- e +**:
 - Para explorar el menú
 - Cambie el valor de los parámetros
7. Tecla **ESC/SBY**:
 - pone la bomba en stand_by
 - sale del menu

CARACTERÍSTICAS GENERALES DE LA BOMBA:

- MENU EN 4 IDIOMAS: ITALIANO, INGLÉS, FRANCÉS, ESPAÑOL
- SELECCIÓN DE CONTROL DE pH o mV (Rx) EN LA PROGRAMACIÓN
- 3 TIPOS DE OPERACIÓN POSIBLES: CONSTANTE, ON / OFF, PROPORCIONAL
- ALARMA DE SOBREDOSIS
- INICIO TARDÍO
- RESTAURACIÓN VALORES DE FÁBRICA
- CONTROL DEL FLUJO DE AGUA
- CONTROL DE NIVEL
- SEÑAL OVER RANGE Y UNDER RANGE DE MEDICIÓN
- STOP DE DOSIFICACIÓN (STAND BY)
- SEÑAL DE CAUDAL % INSTANTÁNEO

VALORES DE FÁBRICA

tipo pH:

- FUNCIONAMIENTO: **Prop**
- SETPOINT: **7,2 pH**
- DIRECCIÓN DE DOSIFICACIÓN : **Acid**
- FRECUENCIA DE INYECCIÓN: **100% (150 imp / min)**
- TIEMPO DE ALARMA: **0unit (desactivado)**
- RETARDO INICIAL: **0 segundos**

tipo Rx:

- FUNCIONAMIENTO: **Prop**
- SETPOINT: **730mV**
- DIRECCIÓN DE DOSIFICACIÓN: **Oxid**
- FRECUENCIA DE INYECCIÓN: **100% (150 imp/min)**
- TIEMPO DE ALARMA: **0unit (desactivado)**
- RETARDO INICIAL: **0 segundos**

RESTAURACIÓN VALORES DE FÁBRICA

Restaur.
Enter



Comprimir y suelte rápidamente la tecla CAL y luego + y - hasta que aparezca "Restaur. Enter". Comprimir CAL para confirmar. La bomba vuelve automáticamente a medir con los valores de la programación y calibración de fábrica.

LAS CONEXIONES DE LA BOMBA

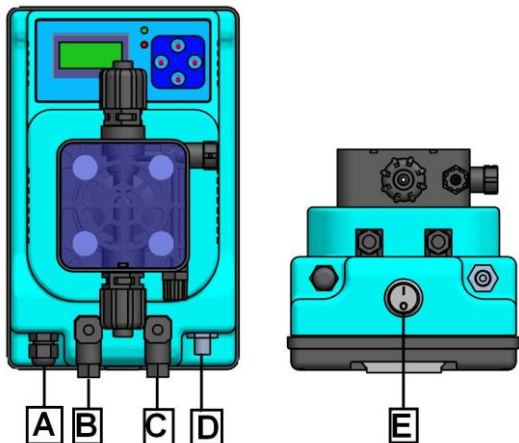

- A - cable de alimentación eléctrica de 230V-50Hz (a petición: 115 ~)
- B - conector de la sonda de nivel (contactos 3 y 4). **OPCIONAL**
- C - conector del sensor de flujo (contactos 3 y 4). **OPCIONAL**
- D - conector BNC sonda de pH o de mV (Rx)
- E - on_off interruptor. **OPCIONAL**

STAND BY (STOP)

	<p>Manteniendo presionada la tecla ESC / SBY por 2 segundos durante la operación, la bomba se pone en un estado de stand-by:</p> <p>1) DEJA LA DOSIFICACIÓN 2) LED verde de on parpadea</p>
<p>Stop 0% 8.21pH</p>	<p>3) En la operación PROPORCIONAL el display visualiza: "Stop 0%" en la primera fila y la medición real en la segunda línea (ver figura a la derecha)</p>
<p>Stop 50% 8.21pH</p>	<p>3) En la operación Manual y ON-OFF el display visualiza: "Stop" y la % e la frecuencia programada en la primera línea y la medición real en la segunda línea (ver figura) La nueva presión de la tecla ESC/SBY por 2 segundos hace volver la bomba en el estado de funcionamiento inicial.</p>

STRUTTURA DEL MENU

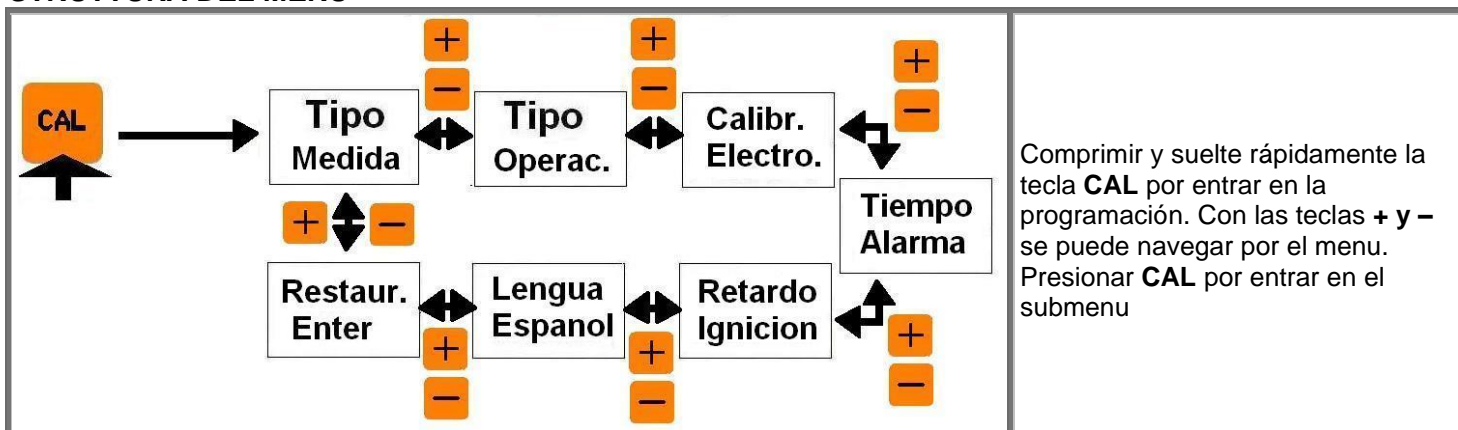

SELECCIÓN DE LENGUAJE

<p>Lengua Espanol</p>	<p>Comprimir y suelte rápidamente la tecla CAL y moverse por el menú con las teclas + y - hasta que el display muestra la selección de idioma. Pulse CAL y luego las teclas + y - para elegir: Lengua Espanol Pulse CAL para confirmar y ESC para volver a la medición</p>
------------------------------	--

SELECCIÓN DEL TIPO DE MEDIDA

<p>Tipo Medida</p>	<p>Tipo pH Tipo Rx</p>	<p>Comprimir y suelte rápidamente la tecla CAL y moverse por el menú con la teclas + y - hasta que el display visualiza "Tipo Medida". Pulse CAL por entrar y luego las teclas + y - para elegir : pH o Rx.. Pulse CAL para confirmar y ESC para volver a la medición</p>
---------------------------	--	--

RETARDO DE IGNICIÓN

<p>Retardo 7.32pH</p>	<p>¿QUÉ ES? El retardo de ignición es el tiempo en segundos (0-999sec) que la bomba espera después de su ignición para inyectar el producto químico. Durante este tiempo el display visualiza el mensaje "Retardo" en la primera línea y la medición en la segunda línea. (Ver figura). La bomba está desactivada dosis, pero se puede acceder al menú para cambiar los parámetros y calibraciones.</p>	
<p>Retardo Ignicion</p>	<p>Retardo 0 sec.</p>	<p>MODIFICACIÓN DE RETARDO DE IGNICIÓN Comprimir y suelte rápidamente la tecla CAL y moverse por el menú con las teclas + y - hasta que el display visualiza "Retardo Ignicion". Pulse CAL para entrar y usar las teclas + y - por elegir el retardo en segundos de 0 a 999. Pulse CAL para confirmar y ESC para volver a la medición.</p>

TIEMPO ALARMA

<p>Tal 29% 8.21pH</p>	<p>¿QUÉ ES? El tiempo de alarma está expresada en unit (unidades) de dosificación. Una unidad de dosificación es equivalente a 150 inyecciones de productos químicos. El conteo de estas inyecciones comienza desde 0 hasta el momento en que la bomba se inicia la dosis después de la ignición, se incrementa durante las inyecciones, se suspende durante la alarma de nivel y durante el stand_by, se resetea si se interrumpe la alimentación eléctrica, si la medida</p>
----------------------------------	---

llega el punto de consigna y durante la alarma de flujo. Cuando el conteo llega el valor del parámetro almacenado en el tiempo de alarma, la bomba va en alarma de tiempo:

- 1) cesación de las inyecciones (no hay tensión al electroimán)
- 2) el led verde de ON parpadea
- 3) El display muestra: "Tal " y la % del caudal en la primera línea y la medida en la segunda línea



Manteniendo presionada la tecla **ESC** por 2 segundos se retorna la bomba en funcionamiento y se resetea el conteo que se reinicia automáticamente cuando la bomba comience a inyectar.

Tiempo Alarma



Tiempo 0 unit



SELECCIÓN DEL TIEMPO DE ALARMA

Comprimir y suelte rápidamente la tecla **CAL** y moverse por el menú con las teclas **+ y -** hasta que el display visualiza "Tiempo Alarma". Pulse **CAL** para entrar y usar las teclas **+ y -** por elegir el tiempo en unidades de 0 a 120 unit. Pulse **CAL** para confirmar y **ESC** para volver a la medición

MOD	l/h	1 unit	Tiempo Alarma= 2000cc :(unit_cc)
ME3-PH/RX 04/12	4	66.6cc	30 unit
ME3-PH/RX 04/18	4	66.6cc	30 unit
ME3-PH/RX 05/10	5	83.3cc	24 unit
ME3-PH/RX 06/15	6	100cc	20 unit
ME3-PH/RX 10/2	10	166.6cc	12 unit
ME3-PH/RX 26/2	26	433.3cc	5 unit
ME3-PH/RX 30/1	30	500cc	4 unit

EJEMPLO para el cálculo del tiempo de alarma para la dosificación de 2 litros (=2000cc) de químicos a la presión de la placa de la bomba.

NOTA: El tiempo de alarma no tiene ningún efecto en el tipo de operación manual

CONTROL DE NIVEL



Nivel
7.32pH

El cierre del contacto de nivel, libre de tensión, durante el funcionamiento de la bomba, en cualquiera modalidades ella se encuentra, provoca:

- 1) el cese de la actividad de dosificación
- 2) el encendido parpadeante del led verde de **ON**
- 3) el display alterna entre la primera línea la inscripción "**Nivel**" en la segunda línea muestra la medida real. La reapertura del contacto de nivel hace volver la bomba en el estado de **FUNCIONAMIENTO** congruente con las entradas actuales de la bomba.

NOTA: La alarma de nivel provoca la suspensión (pero no la reinicialización) de la cuenta del tiempo de alarma.

CONTROL DEL FLUJO



Flujo
7.32pH

El cierre del contacto de flujo, libre de tensión, durante el funcionamiento de la bomba, en cualquiera modalidades ella se encuentra, provoca:

- 3) el cese de la actividad de dosificación
- 4) el encendido parpadeante del led verde de **ON**
- 5) el display alterna entre la primera línea la inscripción "**Flujo**" en la segunda línea muestra la medida real.

La reapertura del contacto de flujo hace volver la bomba en el estado de **FUNCIONAMIENTO** congruente con las entradas actuales de la bomba.

NOTA: La alarma de flujo provoca la reinicialización de la cuenta del tiempo de alarma.

SEÑALES DE O.R y U.R

La pantalla escribe **O.R (Over Range)** cuando la medida supera el máximo medible.

La pantalla escribe **U.R (Under Range)** cuando la medida es inferior al límite mínimo medible.

El LED verde on parpadea rápidamente.

Si la bomba está en funcionamiento **Manual** el dosaje no se bloquea.

Si la bomba está en funcionamiento **ON-OFF y Proporcional** el dosaje se bloquea.

TIPOS DE OPERACIÓN POSIBLES



	<p>Hay 3 tipo de Operación posibles:</p> <p>Manual (constante): dosificación en número constante de inyecciones por minutos definidi en la programación tal como se define en la siguiente sección.</p> <p>Proporcional: proporcional a la distancia de la medida desde el Setpoint deseado. Rango de proporcionalidad: 1pH o 100mV</p> <p>On-Off: dosificación de tipo constante que se activa cuando la medida se aleja del Setpoint. Hysteresi total centrada en el Setpoint: 0.1 pH o 10mV</p>
--	---

PROGRAMACIÓN DE LA OPERACIÓN MANUAL (CONSTANTE) y VISUALIZACIÓN



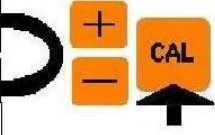
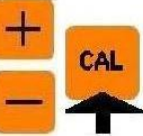

	<p>Comprimir y suelte rápidamente la tecla CAL y moverse por el menú con las teclas + y - hasta que el display visualiza "TIPO De Operac.". Pulse CAL para entrar y usar las teclas + y - por elegir "Tipo Manual" y confirmar con CAL.</p> <p>El display visualiza "Freq." con el porcentaje previamente elegido. Ajustar con + y - el valor de este y confirme la selección con CAL. Presione ESC para volver a la medición con la operación Manual ahora programada.</p> <p>El número de inyecciones por minuto que hace la bomba es igual al porcentaje seleccionado de la frecuencia máxima. Ejemplo: 80% significa 120 impulsos por minuto: $150\text{imp}/\text{min} \times 0,8 = 120 \text{ impulsos} / \text{min}$</p> <p>En la operación manual el display escribe en la primera línea "Man" y el porcentaje de frecuencia de las inyecciones programada. La segunda línea muestra la medida.</p>
--	--

PROGRAMACIÓN DE LA OPERACIÓN DEL TIPO pH

PROGRAMACIÓN DE LA OPERACIÓN ON-OFF pH Y VISUALIZACIÓN

Tipo On-Off		Comprimir y suelte rápidamente la tecla CAL y con las teclas + y - visualizar "TIPO De Operac.". Pulse CAL para entrar y usar las teclas + y - por elegir "Tipo On-Off" y confirmar con CAL .
SetPoint 7.00pH		El display visualiza el valor del Setpoint previamente elegido. Ajustar con + y - el valor de este y confirme la selección con CAL .
SetPoint Acid SetPoint Alk		El display visualiza la dirección de la dosificación Acid o Alk previamente elegido. Ajustar con + y - el valor de este y confirme la selección con CAL . Seleccione Acid si desea la dosificación para los valores de pH por encima del Setpoint. Seleccione Alk si desea la dosificación para los valores de pH de menos de SetPoint
Freq 100%		El display visualiza "Freq." con el porcentaje de la frecuencia de inyecciones máxima (150 imp / min) previamente elegido. Ajustar con + y - el valor de este y confirme la selección con CAL . Presione ESC para volver a la medición con la operación ON-OFF ahora programada.
On 100% 7.11pH		En la Operación ON-OFF si la bomba inyectora el display escribe en la primera línea "On" y el porcentaje de inyecciones programada, si la bomba no inyectora el display escribe en la primera línea "Off" y el porcentaje de inyecciones programada. La segunda línea muestra la medida.

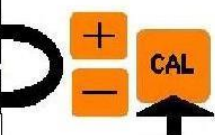
PROGRAMACIÓN DE LA OPERACIÓN PROPORCIONAL pH Y VISUALIZACIÓN

Tipo Prop		Intervalo de proporcionalidad =1pH Comprimir y suelte rápidamente la tecla CAL y con las teclas + y - visualizar "TIPO De Operac.". Pulse CAL para entrar y usar las teclas + y - por elegir "Tipo Prop" y confirmar con CAL .
SetPoint 7.00pH		El display visualiza el valor del Setpoint previamente elegido. Ajustar con + y - el valor de este y confirme la selección con CAL .
SetPoint Acid SetPoint Alk		El display visualiza la dirección de la dosificación Acid o Alk previamente elegido. Ajustar con + y - el valor de este y confirme la selección con CAL . Seleccione Acid si desea la dosificación para los valores de pH por encima del Setpoint. Seleccione Alk si desea la dosificación para los valores de pH de menos de SetPoint
Freq 100%		El display visualiza "Freq." con el porcentaje de la frecuencia de inyecciones máxima (150 imp / min) previamente elegido. Ajustar con + y - el valor de este y confirme la selección con CAL . Presione ESC para volver a la medición con la operación proporcional ahora programada.
Prop 100% 7.11pH		En la Operación PROPORCIONAL el display escribe en la primera línea "Prop" y el porcentaje de inyecciones que la bomba hace en comparación con la frecuencia de las inyecciones programadas. La segunda línea muestra la medida.



En cualquier punto de programación del setpoint si no es comprimido ninguna tecla (+, -, CAL) durante 60 segundos, la bomba sale de la programación con los parámetros nuevos hasta aquel momento

CALIBRACIÓN DE LA Sonda TIPO pH

Atención,

Ser seguro que la solución tapón usada en la calibración empareja siempre el valor indicado, y que no están contaminados.

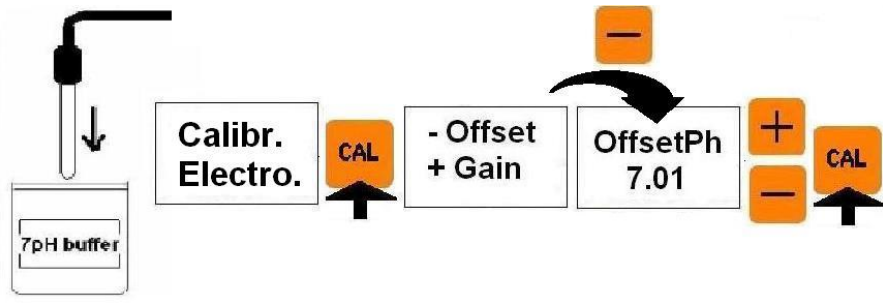
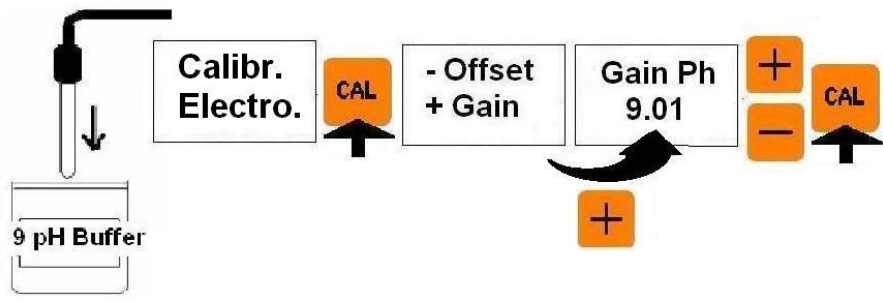
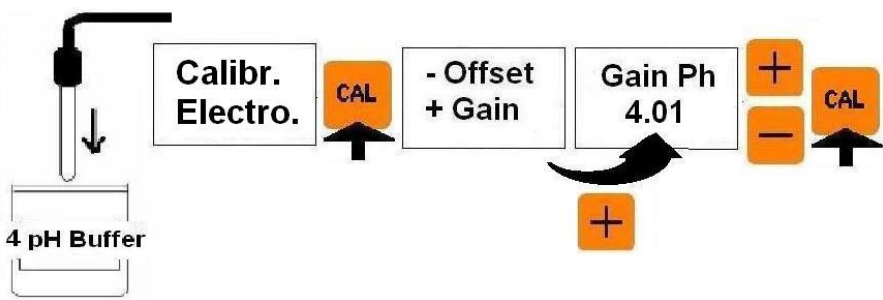

<p>BUFFER 7.01pH</p> 	<p>CALIBRACIÓN DE L'OFFSET</p> <p>Insertar la sonda de pH en la solución a pH 7. Espere para estabilizar la lectura en el display. Comprimir y suelte rápidamente la tecla CAL y luego + y - por elegir "Calibr. Electro." y confirmar con CAL. Pulse la tecla - para calibrar el offset de la sonda. Ajuste (si es necesario) el valor de lectura de la solución tampón con las teclas + y - y confirme con CAL.</p> <p>Si el mensaje "Calibración imposible" aparece, la calibración no se hizo. Lea el siguiente párrafo: MENSAJES DE LA BOMBA. Si no hay ningún mensaje de error la calibración se ha realizado</p>
<p>BUFFER 9.01pH</p>  <p>BUFFER 4.01pH</p> 	<p>CALIBRACIÓN DEL GAIN</p> <p>Limpiar la sonda con agua y luego Insertarla en la solución tampón a pH 9 o 4. Espere para estabilizar la lectura en el display. Comprimir y suelte rápidamente la tecla CAL y luego + y - por elegir "Calibr. Electro." y confirmar con CAL. Pulse la tecla + para calibrar el GAIN de la sonda. Ajuste (si es necesario) el valor de lectura de la solución tampón con las teclas + y - y confirme con CAL.</p> <p>Si el mensaje "Calibración imposible" aparece, la calibración no se hizo. Lea el siguiente párrafo: MENSAJES DE LA BOMBA. Si no hay ningún mensaje de error la calibración se ha realizado.</p>

MENSAJES DE LA BOMBA



<p>Calibr. Imposib.</p>	<p>INDICA QUE LA CALIBRACIÓN ES IMPOSIBLE. REPETIR LA CALIBRACIÓN.</p> <p>Si después de haber repetido la calibración aparece de nuevo el mensaje:</p> <ul style="list-style-type: none">a) Controlar que la solución no sea contaminada, eventualmente reemplazarla.b) Controlar que la solución elegida sobre el display durante la calibración sea aquel efectivamente usada.c) la sonda de pH podría ser envejecida (reemplazarla).
--------------------------------	--

PROGRAMACIÓN DE LA OPERACIÓN DEL TIPO Rx(mV)

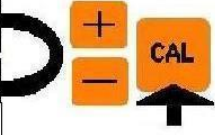
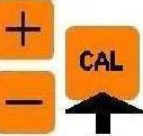
PROGRAMACIÓN DE LA OPERACIÓN ON-OFF Rx Y VISUALIZACIÓN

<p>Tipo On-Off</p> 	<p>Comprimir y suelte rápidamente la tecla CAL y con las teclas + y - visualizar "TIPO De Operac.". Pulse CAL para entrar y usar las teclas + y - por elegir "Tipo On-Off" y confirmar con CAL.</p>
<p>SetPoint 700mV</p> 	<p>El display visualiza el valor del Setpoint previamente elegido. Ajustar con + y - el valor de este y confirme la selección con CAL.</p>
<p>SetPoint Oxid</p> <p>SetPoint Red</p> 	<p>El display visualiza la dirección de la dosificación Red o Oxid previamente elegido. Ajustar con + y - el valor de este y confirme la selección con CAL.</p> <p>Seleccione Red si desea la dosificación para los valores de pH por encima del Setpoint. Seleccione Oxid si desea la dosificación para los valores de pH de menos de SetPoint</p>
<p>Freq 100%</p> 	<p>El display visualiza "Freq." con el porcentaje de la frecuencia de inyecciones máxima (150 imp / min) previamente elegido. Ajustar con + y - el valor de este y confirme la selección con CAL. Presione ESC para volver a la medición con la operación ON-OFF ahora programada.</p>
<p>On 100%</p> <p>510mV</p>	<p>En la Operación ON-OFF si la bomba inyectora el display escribe en la primera línea "On" y el porcentaje de inyecciones programada, si la bomba no inyectora el display escribe en la primera línea "Off" y el porcentaje de inyecciones programada. La segunda línea muestra la medida.</p>

PROGRAMACIÓN DE LA OPERACIÓN PROPORCIONAL Rx Y VISUALIZACIÓN

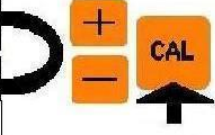
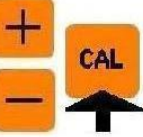
<p>Tipo Prop</p> 	<p>Intervalo de proporcionalidad =100mV</p> <p>Comprimir y suelte rápidamente la tecla CAL y con las teclas + y - visualizar "TIPO De Operac.". Pulse CAL para entrar y usar las teclas + y - por elegir "Tipo Prop" y confirmar con CAL.</p>
<p>SetPoint 700mV</p> 	<p>El display visualiza el valor del Setpoint previamente elegido. Ajustar con + y - el valor de este y confirme la selección con CAL.</p>
<p>SetPoint Oxid</p> <p>SetPoint Red</p> 	<p>El display visualiza la dirección de la dosificación Red o Oxid previamente elegido. Ajustar con + y - el valor de este y confirme la selección con CAL.</p> <p>Seleccione Red si desea la dosificación para los valores de pH por encima del Setpoint. Seleccione Oxid si desea la dosificación para los valores de pH de menos de SetPoint</p>
<p>Freq 100%</p> 	<p>El display visualiza "Freq." con el porcentaje de la frecuencia de inyecciones máxima (150 imp / min) previamente elegido. Ajustar con + y - el valor de este y confirme la selección con CAL. Presione ESC para volver a la medición con la operación proporcional ahora programada.</p>
<p>Prop 100%</p> <p>500mV</p>	<p>En la Operación PROPORCIONAL el display escribe en la primera línea "Prop" y el porcentaje de inyecciones que la bomba hace en comparación con la frecuencia de las inyecciones programadas.</p> <p>La segunda línea muestra la medida.</p>



En cualquier punto de programación del setpoint si no es comprimido ninguna tecla (+, -, **CAL**) durante 60 segundos, la bomba sale de la programación con los parámetros nuevos hasta aquel momento

CALIBRACIÓN DE LA Sonda TIPO Rx

Atención,

Ser seguro que la solución tampón usada en la calibración empareja siempre el valor indicado, y que no están contaminados.

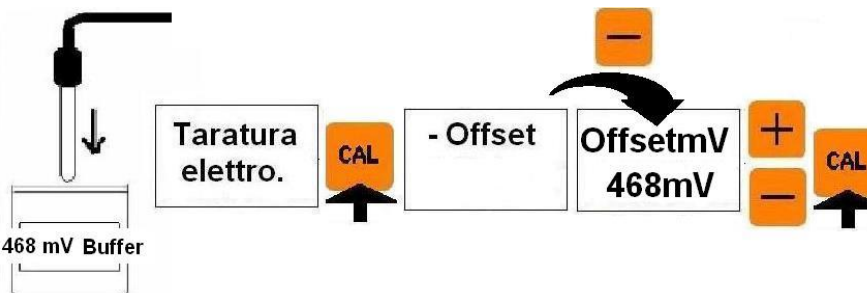
<p>BUFFER 468mV</p>  <p>Taratura elettro. CAL - Offset OffsetmV 468mV + - CAL</p>	<p>CALIBRACIÓN DE L'OFFSET</p> <p>Insertar la sonda de Rx en la solución tampón 468mV. Espere para estabilizar la lectura en el display. Comprimir y suelte rápidamente la tecla CAL y luego + y - por elegir "Calibr. Electro." y confirmar con CAL. Pulse la tecla - para calibrar el offset de la sonda. Ajuste (si es necesario) el valor de lectura de la solución tampón con las teclas + y - y confirme con CAL. Si el mensaje "Calibración imposible" aparece, la calibración no se hizo. Lea el siguiente párrafo: MENSAJES DE LA BOMBA. Si no hay ningún mensaje de error la calibración se ha realizado</p>
--	--

MENSAJES DE LA BOMBA

<p>Calibr. Imposib.</p>	<p>INDICA QUE LA CALIBRACIÓN ES IMPOSIBLE. REPETIR LA CALIBRACIÓN.</p> <p>Si después de haber repetido la calibración aparece de nuevo el mensaje:</p> <ul style="list-style-type: none">a) Controlar que la solución no sea contaminada, eventualmente reemplazarla.b) Controlar que la solución elegida sobre el display durante la calibración sea aquel efectivamente usada.c) la sonda de pH podría ser envejecida (reemplazarla).
--------------------------------	--

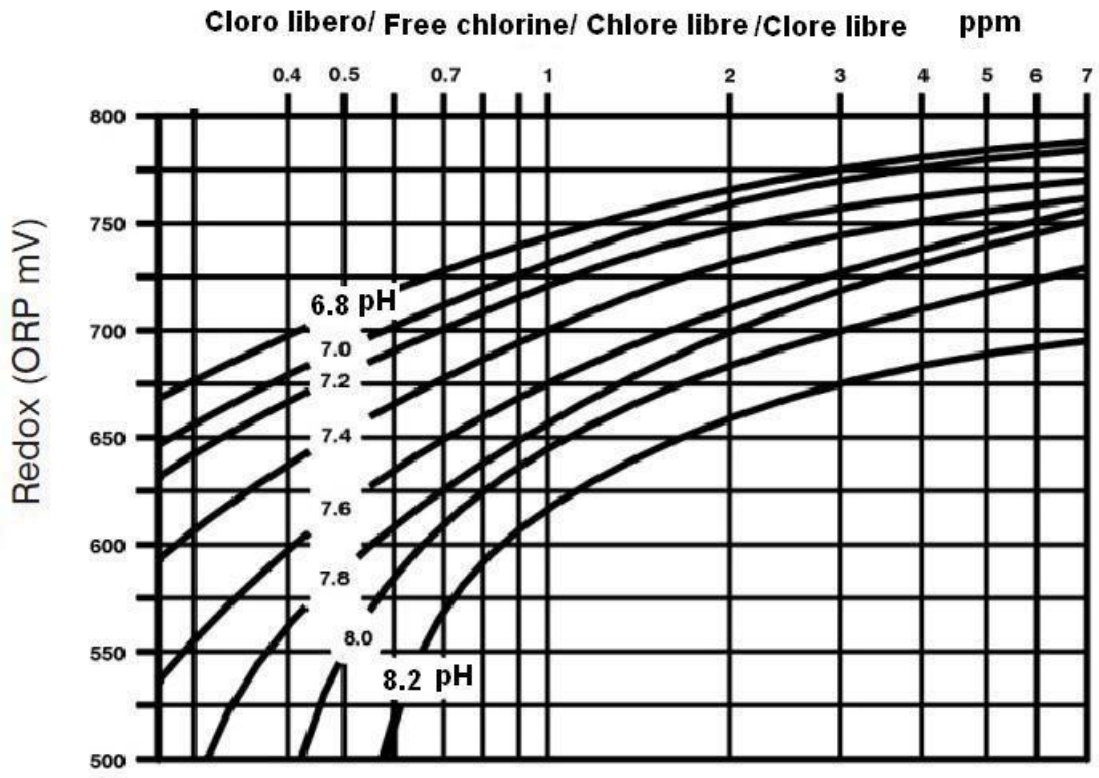

MICRODOS SRL
Sede legale: Via maestri del lavoro, 5 - 02010 Vazia (Ri)
tel. +39 0746 229064 fax. +39 0746 221224 Web site: www.microdos.it E-mail: info@microdos.it