

MANUALE DI PROGRAMMAZIONE IT

PROGRAMMING INSTRUCTIONS UK

MANUEL DE RÉGLAGE FR

MANUAL DE REGULACIÓN ES



MP2-HT mA

MICRODOS SRL

Sede legale: Via maestri del lavoro, 5
02010 Vazia (Ri)

tel. +39 0746 229064

fax. +39 0746 221224

Web site: www.microdos.it

E-mail: info@microdos.it

INDEX

ITALIANO	6
DESCRIZIONE DELLE CARATTERISTICHE E DEL FUNZIONAMENTO	6
DESCRIZIONE PANNELLO FRONTALE.....	6
FUNZIONI GENERALI.....	6
CONNESSIONI.....	7
REGOLAZIONI DI FABBRICA	7
RIPRISTINO REGOLAZIONI DI FABBRICA.....	7
DISPLAY NEI DIVERSI FUNZIONAMENTI	8
STAND BY (STOP)	8
TASTO PRIME	8
CONTROLLO DI LIVELLO (A RICHIESTA)	8
STRUTTURA DEL MENU PRINCIPALE.....	9
MENU SET UP	9
LINGUA	9
PASSWORD.....	10
ENABLE (A RICHIESTA)	10
ROTTURA TUBO (A RICHIESTA).....	11
MENU CALIBRAZIONE (della portata).....	11
METODO VELOCE (TABELLA PORTATA):.....	12
METODO EMPIRICO	12
MENU UTILITÀ.....	13
RITARDO DI ACCENSIONE	13
RIPRISTINO PARAMETRI DI PROGRAMMAZIONE	13
MENU RELÉ (A RICHIESTA)	13
ALLARME	14
INCLUDERE / ESCLUDERE IL RITARDO DI ACCENSIONE	14
MENU DOSAGGIO.....	14
DOSAGGIO MANUALE.....	15
DOSAGGIO mA.....	15

ENGLISH	17
DESCRIPTION OF CHARACTERISTICS AND OPERATION	17
FRONT PANEL DESCRIPTION.....	17
GENERAL FUNCTIONS.....	17
CONNECTIONS	18
DEFAULT SETTINGS	18
DEFAULT SETTINGS RESTORE.....	18
DISPLAY IN DIFFERENT DOSING	19
STAND BY (STOP)	19
PRIME BUTTON	19
LEVEL PROBE CONTROL (OPTIONAL).....	19
STRUCTURE OF THE MAIN MENU	20
MENU SET UP	20
LANGUAGE	20
PASSWORD.....	21
ENABLE (OPTIONAL)	21
BROKEN HOSE (OPTIONAL)	22
CALIBRATION MENU (of flowrate).....	22
FAST WAY (TABLE FLOWRATE):	23
EMPIRICAL WAY	23
MENU UTILITY	24
DELAY ON	24
RESET PROGRAMMING PARAMETERS	24
MENU RELAY (OPTIONAL).....	24
ALARM.....	25
DELAY ON	25
MENU DOSING.....	25
MANUAL DOSING	26
mA DOSING	26

FRANCAIS.....	28
DESCRIPTION DES CARACTERISTIQUES ET DU FONCTIONNEMENT	28
DESCRIPTION DU PANNEAU AVANT	28
FONCTIONS GÉNÉRALES:.....	28
CONNECTIONS	29
REGLAGES PAR DEFAUT	29
RESTAURATION DES PARAMETRES D'USINE	29
AFFICHAGE DANS DIFFÉRENTES TYPES DE DOSAGE.....	30
STAND BY (STOP)	30
BOUTON PRIME.....	30
CONTRÔLE DU NIVEAU (OPTIONNEL)	30
STRUCTURE DU MENU PRINCIPAL	31
MENU SET UP	31
LANGUE	31
PASSWORD.....	32
ENABLE (OPTIONNEL).....	32
RUPTURE TUBE (OPTIONNEL).....	33
MENU ETALONNAGE (du debit)	33
MODE RAPIDE (TABLEAU DEBIT):	34
MODE EMPIRIQUE	34
MENU UTILITAIRE.....	35
RETARD D'ALLUMAGE	35
RESTAURER LES PARAMÈTRES DE PROGRAMMATION D'USINE	35
MENU RELAIS (OPTIONNEL).....	35
ALARME.....	36
RETARD D' ALLUMAGE	36
MENU DOSAGE.....	36
DOSAGE MANUELLE	37
DOSAGE mA	37

ESPAÑOL	39
DESCRIPCIÓN DE LAS CARACTERÍSTICAS Y FUNCIONAMIENTO.....	39
DESCRIPCION DEL PANEL FRONTAL	39
FUNCIONES GENERALES:.....	39
CONEXIONES	40
PARÁMETROS DE FÁBRICA	40
RESTAURACIÓN DE AJUSTES DE FÁBRICA	40
PANTALLA EN DIFERENTES OPERACIONES	41
STAND BY (STOP)	41
TECLA PRIME	41
CONTROL DE NIVEL (OPCIONAL).....	41
ESTRUCTURA DEL MENÚ PRINCIPAL	42
MENÚ SET UP	42
IDIOMA.....	42
CONTRASEÑA.....	43
ENABLE (OPCIONAL)	43
RUPTURA TUBO (OPCIONAL)	44
MENU DE CALIBRACIÓN (de caudal)	44
MODO RÁPIDO (TABLA CAUDAL)	45
MODO EMPÍRICO	45
MENÚ UTILIDADES	46
RETARDO DE IGNICION	46
RESTAURACIÓN DE PARÁMETROS DE PROGRAMACIÓN	46
MENU RELÉ (OPCIONAL)	46
ALARMA	47
RETARDO DE IGNICIÓN	47
MENÚ DE DOSIFICACIÓN	47
DOSIFICACION MANUAL.....	48
DOSIFICACION mA	48

DESCRIZIONE DELLE CARATTERISTICHE E DEL FUNZIONAMENTO

Le pompe dosatrici serie "MP2-HT mA" sono ideali per il dosaggio nelle più svariate applicazioni.

Possano funzionare in modo Manuale, mA e la portata è regolabile dal 10% al 100% della portata massima. Regolano la portata variando la velocità di rotazione del portarullini.

Opzionalmente possono ospitare un sensore di rottura del tubo peristaltico che in caso di perdite di prodotto chimico blocca il dosaggio e possono opzionalmente disporre di una uscita relè, configurabile per la ripetizione di un allarme (per esempio: allarme di livello, rottura del tubo peristaltico, etc).

DESCRIZIONE PANNELLO FRONTALE

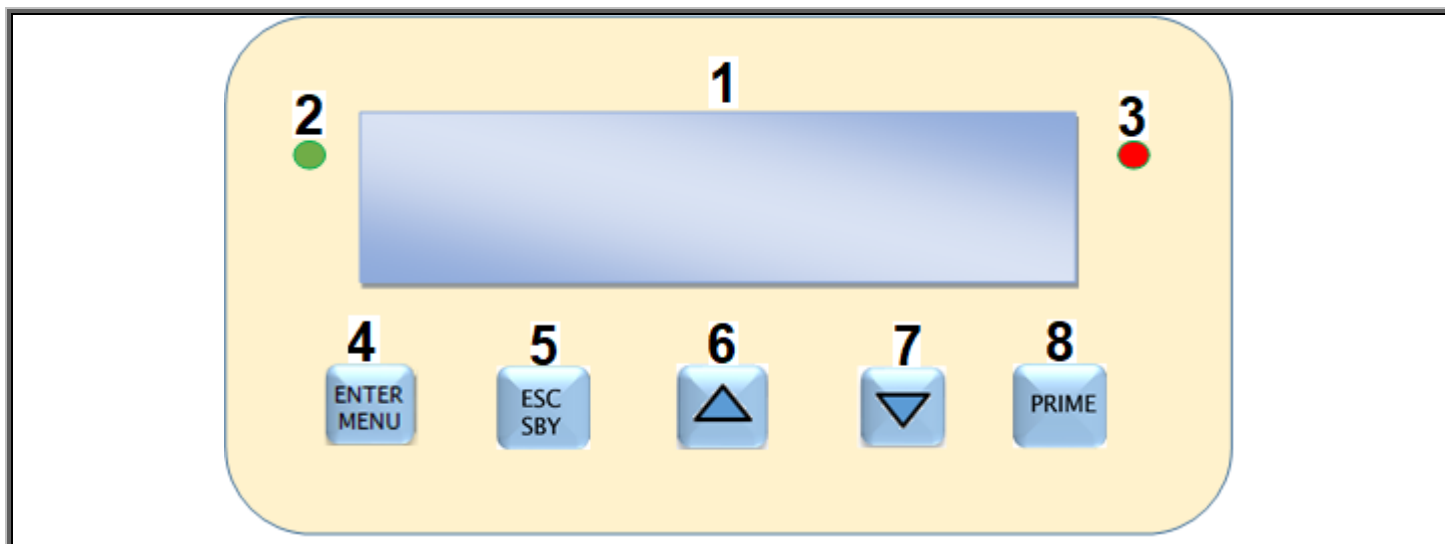

1. Display LCD 16 x 2 caratteri retroilluminato

2. Led **verde**:
 ▪ fisso = POMPA ACCESA
 ▪ lampeggiante = POMPA IN ALLARME

3. Led **rosso**: ▪ lampeggiante segnala il dosaggio del prodotto chimico

4. Tasto **Enter/Menu**: ▪ fa entrare in programmazione
 ▪ Salva/Conferma le modifiche

5. Tasto **ESC/SBY**: ▪ fa uscire dai menu
 ▪ mette la pompa in Stand-by

6 / 7. Tasto **▲ ▼**: ▪ Fa navigare all'interno del menu
 ▪ Modifica il valore dei parametri

8. Tasto **Prime**: ▪ fa adescare la pompa

FUNZIONI GENERALI

- VISUALIZZAZIONE DEL TIPO DI DOSAGGIO
- SEGNALAZIONE DELLA **PORTATA % ISTANTE PER ISTANTE**
- 2 POSSIBILI **TIPI DI DOSAGGIO**: MANUALE, mA
- **MENU IN 4 LINGUE**: ITALIANO, INGLESE, FRANCESE, SPAGNOLO
- POSSIBILITA' INSERIMENTO **PASSWORD**
- **RITARDO DI ACCENSIONE**
- **TASTO DI ADESCAMENTO**
- **RELE'** DI ALLARME (CONTATTO PULITO) E' UNA USCITA PER LA RIPETIZIONE DEGLI ALLARMI
- **RIPRISTINO** DEI PARAMETRI DI DEFAULT
- STOP DEL DOSAGGIO (**STAND_BY**)
- CONTROLLO DI **LIVELLO** DI FINE PRODOTTO
- SEGNALE DI **ENABLE** DI INGRESSO
- **SENSORE DI ROTTURA TUBO**

CONNESSIONI

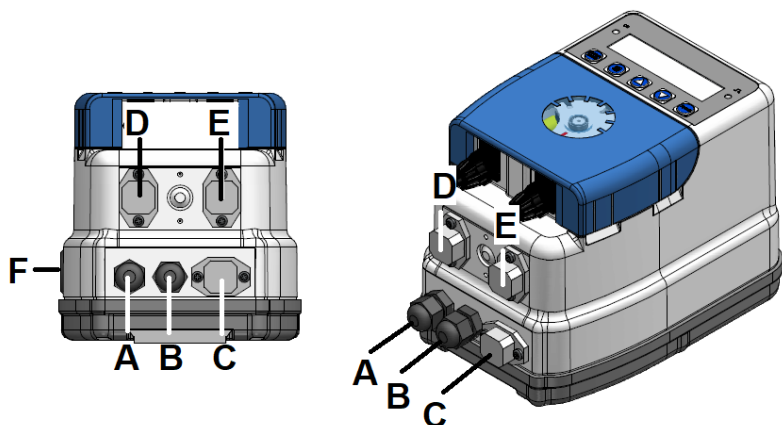

A - è il cavo di alimentazione elettrica, 90-250V-50-60Hz

B - è l'ingresso di Enable o consenso al dosaggio (110Vac; 230Vac; a richiesta 24V). **OPTIONAL**

C - è il connettore dell'uscita relè per gli allarmi (contatti 3 e 4). (5A 250Vca/30Vdc) **NORMALMENTE APERTO. OPTIONAL.**

D - è il connettore del sensore di livello (contatti 3 e 4). **OPTIONAL.**

E - è il connettore per l'ingresso mA (contatti 3 (+) e 4(-)).

F - è l'interruttore On/Off. **OPTIONAL**

REGOLAZIONI DI FABBRICA

PASSWORD = NON INSERITA

Ritardo accensione: 0 minuti

Enable (optional): attivo

Rottura tubo (optional): attivo

- **FUNZIONAMENTO: mA**
- mA Min: **4.0mA**
- % Min: **10%**
- Dos.Min: **disattivo**
- mA Max: **20.0mA**
- % Max: **100%**
- Dos.Max: **attivo**

RIPRISTINO REGOLAZIONI DI FABBRICA



Premere il tasto **ENTER/MENU** per 3 secondi per entrare in programmazione.

Con il tasto ▼ spostare il cursore su **"Utilità"**. Premere **ENTER** per entrare nel sottomenu.

Premere il tasto ▼ per spostare il cursore su **"Ripristino"**. Premere **ENTER** per entrare.

Con il tasto ▼ far comparire **"Si"** su Conferma. Premere **ENTER**.

Automaticamente la pompa ripristina le regolazioni di fabbrica.

Premere per 3 secondi il tasto **ESC** per uscire dalla programmazione.

DISPLAY NEI DIVERSI FUNZIONAMENTI

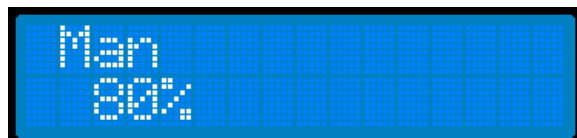

- **Dosaggio: Manuale** con ciclo disattivo;
- La pompa è in dosaggio con Portata 80%

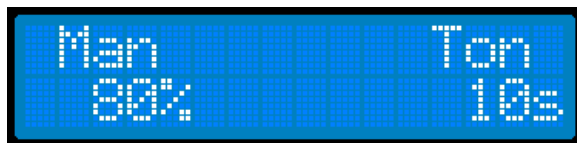

- **Dosaggio: Manuale** con ciclo attivo;
- La pompa sta dosando con portata 80% per un Ton di 10 secondi

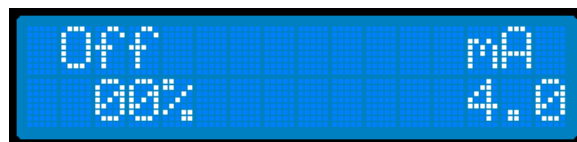

- **Dosaggio: mA**
- La pompa non dosa, riceve in ingresso 4mA.

STAND BY (STOP)

La pressione prolungata del tasto **ESC/SBY** durante il funzionamento pone la pompa in stato di stand by/Stop:

1. CESSA IL DOSAGGIO
2. LED verde di on lampeggia
3. display visualizza alternativamente “**Stby**” e il tipo di dosaggio e portata %

La nuova pressione del tasto **ESC/SBY** fa tornare la pompa nello stato di funzionamento.

TASTO PRIME

La pressione breve del tasto **PRIME** durante il funzionamento pone la pompa in stato di Prime (adescamento):

1. La pompa dosa al 25%
2. LED verde fisso ; LED rosso lampeggia
3. Display visualizza “**Prime 25%**”

La nuova pressione del tasto **PRIME** fa tornare la pompa nello stato di funzionamento.

NB: se il tasto PRIME viene premuto prolungatamente la pompa doserà all'80% della portata ed il display visualizzerà “Prime 80%”.

CONTROLLO DI LIVELLO (A RICHIESTA)

La chiusura del contatto di livello provoca:

- 1) La cessazione dell'attività di dosaggio
- 2) L'accensione lampeggiante del led verde on
- 3) Il display visualizza alternativamente la scritta “**Livello**” e il tipo di dosaggio

La riapertura del contatto di livello fa tornare la pompa nello stato di FUNZIONAMENTO congruente con gli ingressi attuali.

STRUTTURA DEL MENU PRINCIPALE

	<p>Premere il tasto ENTER/MENU per 3 secondi per entrare in programmazione.</p> <p>Con il tasto ▼ spostare il cursore sui sottomenu di interesse. Premere ENTER per entrare nel sottomenu.</p> <p>Se si vuole abbandonare la programmazione e tornare in misura, premere per 3 secondi il tasto ESC.</p>
--	---

Il menu **Set up** permette di:

scegliere la Lingua, il contrasto del display, la Password di sicurezza; di attivare o disattivare l'ingresso di Enable (abilitazione al dosaggio), il sensore della Rottura del tubo peristaltico.

Il menu **Dosaggio** permette di:

scegliere il tipo di dosaggio tra Manuale, mA.

Il menu **Calibrazione** permette di:

Calibrare la portata, oppure sceglierla dalla etichetta sulla cassa della pompa.

Il menu **Utilità** permette di:

scegliere di programmare oppure no il ritardo di accensione e di ripristinare i parametri di fabbrica della programmazione.

Il menu **Relè** è **opzionale quindi potrebbe non esserci sulla vostra pompa**. Esso permette di:

scegliere il funzionamento del relè di allarme (N.A o N.C) e di includere o escludere dalla segnalazione del relè i vari tipi di allarme (Ritardo di Accensione, Stand by, Livello, Enable, Rottura Tubo).

MENU SET UP

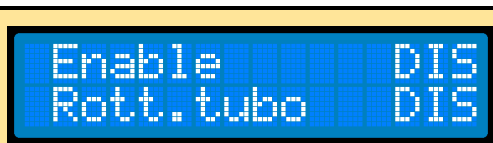
<p>NOTA IMPORTANTE: L'Enable e Rottura Tubo sono optional. Se sulla vostra pompa non sono presenti non sarà possibile accedere ai relativi sottomenu e nel menu comparirà:</p>	
---	---

	<p>Premere il tasto ENTER/MENU per 3 secondi per entrare in programmazione.</p> <p>Con il cursore selezionare Set up e premere ENTER.</p> <p>Posizionare il cursore sulla voce da modificare. Premere ENTER per entrare nel sottomenu e procedere alla modifica.</p> <p>Se si vuole abbandonare la programmazione e tornare in misura, premere per 3 secondi il tasto ESC.</p>
--	---

LINGUA

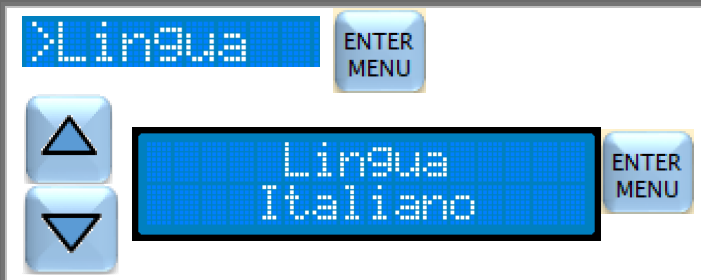
	<p>All'interno del Menu Set up, selezionare con il cursore "Lingua" e premere ENTER.</p> <p>Scegliere "Italiano" con i tasti ▼▲ e premere Enter.</p> <p>Se si vuole abbandonare la programmazione e tornare in misura, premere per 3 secondi il tasto ESC.</p>
--	--

NB: la lingua non viene ripristinata con il reset della pompa (menu Utilità).

PASSWORD

La password protegge la modifica dei menu di **Dosaggio**, **Utilità** e **Relè** e non blocca la **Calibrazione** ed il **Set up**. Di default la password non è presente ed è quindi possibile accedere a tutta la programmazione.

Prima definizione della password:

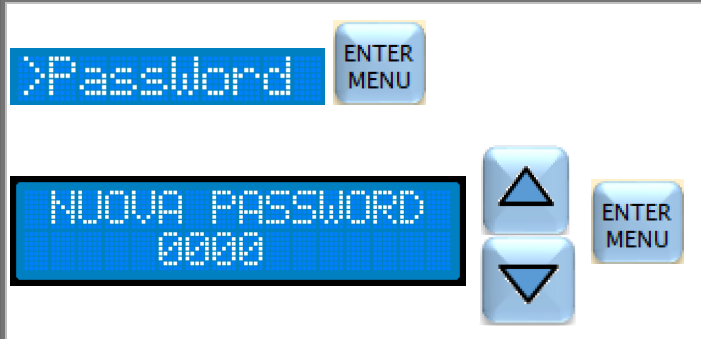
	<p>All'interno del Menu Set up, selezionare con il cursore "Password" e premere ENTER.</p> <p>Si accede così alla definizione cifra per cifra della password. Scegliere la cifra con i tasti ▼▲ e premere ENTER. Dopo la definizione della 4° cifra, la pressione di ENTER salva la password. Prenderne nota accuratamente per non dimenticarla. Nel caso che si dimentichi, <u>chiamare il Servizio di Assistenza</u>.</p> <p>Se si vuole abbandonare la programmazione e tornare in misura, premere per 3 secondi il tasto ESC.</p>
--	---

Cambio della password:

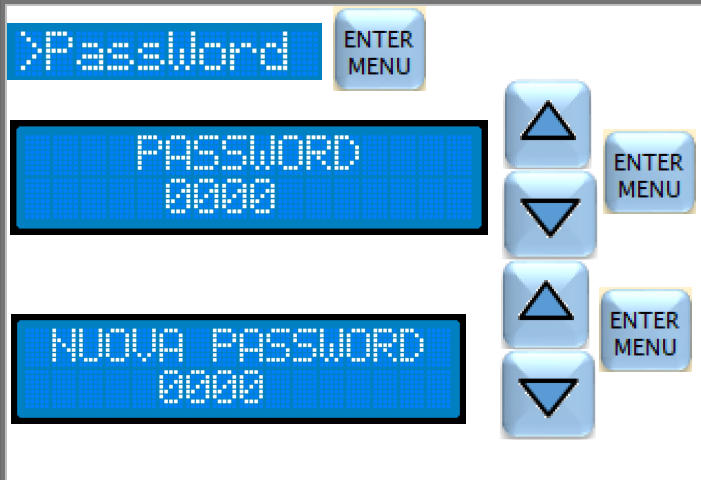
	<p>All'interno del Menu Set up, selezionare con il cursore "Password" e premere ENTER.</p> <p>Inserire cifra per cifra la vecchia password. Scegliere la cifra con i tasti ▼▲ e premere ENTER. Dopo l'inserimento della 4° cifra, la pressione di ENTER, fa passare alla definizione della nuova password.</p> <p>Inserire cifra per cifra la nuova password. Scegliere la cifra con i tasti ▼▲ e premere ENTER. Dopo l'inserimento della 4° cifra, la pressione di ENTER salva la nuova password. Prenderne nota accuratamente per non dimenticarla. Nel caso che si dimentichi, <u>chiamare il Servizio di Assistenza</u>.</p> <p>Se si vuole abbandonare la programmazione e tornare in misura, premere per 3 secondi il tasto ESC.</p>
---	--

ENABLE (A RICHIESTA)

L'ingresso di enable è un ingresso (230Vac-115Vac) che serve ad abilitare la pompa al dosaggio. Nelle piscine questo ingresso si collega in parallelo all'alimentazione della pompa di ricircolo in modo tale che se la filtrazione è ferma la pompa non possa dosare. Per non danneggiare la scheda elettronica non collegare l'enable direttamente in parallelo all'alimentazione elettrica della pompa di ricircolo ma utilizzare sempre un teleruttore/relè.

Nel caso che la vostra pompa abbia l'enable (vedi posizione B pag.7 CONNESSIONI), si può scegliere di attivare questo ingresso oppure no. Nel caso che si scelga di disattivarlo, la pompa non controllerà l'ingresso di enable per dosare il prodotto chimico.

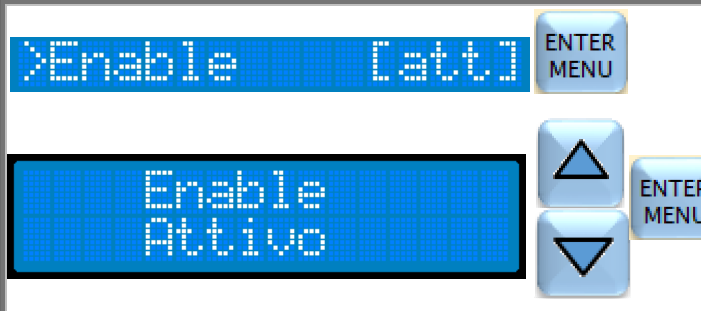
	<p>All'interno del Menu Set up, selezionare con il cursore "Enable" e premere ENTER.</p> <p>Scegliere con i tasti ▼▲ se attivare o disattivare l'ingresso di abilitazione al dosaggio e premere ENTER.</p> <p>Se si vuole abbandonare la programmazione e tornare in misura, premere per 3 secondi il tasto ESC.</p>
--	--

Nel caso che la vostra pompa non abbia inclusa l'opzione enable allora non sarà possibile accedere alla modifica e comparirà la scritta lampeggiante "DIS":

Enable DIS

ROTTURA TUBO (A RICHIESTA)

Che cos'è?

È un sensore che si accorge se il tubo peristaltico si lacera e lascia fuoriuscire il prodotto chimico da dosare.

Quando l'allarme di rottura del tubo scatta, blocca il dosaggio e viene segnalato sul display.



Prima di qualsiasi intervento scollegare la pompa dalla rete di alimentazione!



Durante l'operazione utilizzare sempre le protezioni personali previste dalle avvertenze di uso del prodotto chimico dosato. Per esempio usare guanti, grembiule, occhiali, ecc...

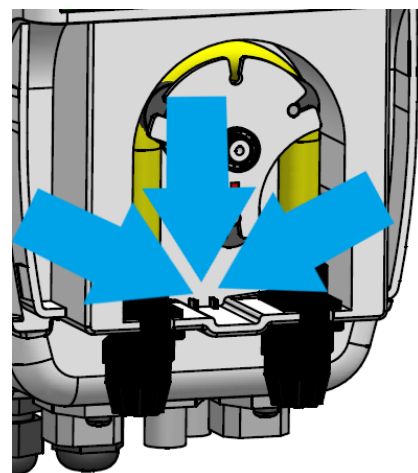

Si deve quindi procedere al cambio del tubo peristaltico. Va inoltre sciacquata e asciugata con molta cura la zona del sensore all'interno del corpo pompa. Si veda l'immagine esplicativa in alto.

Una volta svolta l'operazione in sicurezza si può riaccendere la pompa.

NB: ALLA RIACCENSIONE LA POMPA RICORDA CHE IL TUBO ERA ROTTO. PER USCIRE DALL'ALLARME PREMERE BREVEMENTE IL PULSANTE ESC.

Nel caso che la vostra pompa abbia il sensore di Rottura del tubo peristaltico, si può scegliere di attivare questo ingresso oppure no.

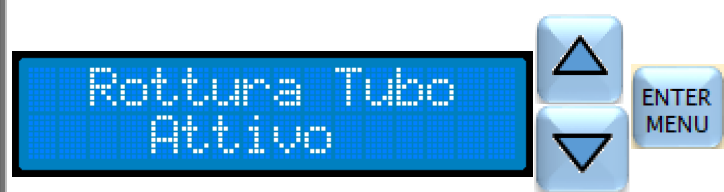
	All'interno del Menu Set up, selezionare con il cursore "Rott.tubo" e premere ENTER .
	Scegliere con i tasti ▼▲ se attivare o disattivare l'ingresso del sensore e premere ENTER . Se si vuole abbandonare la programmazione e tornare in misura, premere per 3 secondi il tasto ESC .

Nel caso che la vostra pompa non abbia inclusa l'opzione di Rottura del Tubo peristaltico allora non sarà possibile accedere alla modifica e comparirà la scritta lampeggiante "DIS":

Rott.tubo DIS

MENU CALIBRAZIONE (della portata)

La definizione della portata della pompa non è necessaria nel funzionamento costante e mA.



In questo modello di pompa il metodo empirico è utile alla determinazione precisa della portata nelle condizioni di lavoro.

La definizione della portata (cioè i litri/ora di prodotto dosato dalla pompa) può essere effettuato in 2 modi.

Un modo veloce (Tabella Portata) tramite la lettura della etichetta identificativa sul lato della pompa.

Un modo empirico e più accurato (Calib.Portata) che tiene conto delle condizioni di lavoro della pompa (rodaggio tubo e motore per esempio).

TUTTE LE POMPE SONO PRECALIBRATE DI FABBRICA CON TABELLA PORTATA. La portata non viene ripristinata con il reset della pompa (menu Utilità)

	Premere il tasto ENTER/MENU per 3 secondi per entrare in programmazione.
	Con il cursore selezionare Calibrazione e premere ENTER .
	Posizionare il cursore sul tipo di calibrazione che si vuole fare. Premere ENTER per entrare nel sottomenu e procedere alla modifica. Se si vuole abbandonare la programmazione e tornare in misura, premere per 3 secondi il tasto ESC .

METODO VELOCE (TABELLA PORTATA):

Leggere il modello di pompa che si possiede sulla etichetta applicata sulla pompa (vedere figura a lato) e scriverlo sul parametro "Tabella portata" come segue:

S/N: xxxxxxxxxxxx

Type: xxxxxxxxxxxx

Code: xxxxxxxxxxxx



90-250Vac 50/60Hz 20W

6l/h 1bar SANT



	<p>All'interno del Menu Calibrazione, selezionare con il cursore "Tabella Portata" e premere ENTER.</p> <p>Leggere sull'etichetta della pompa la portata e con i tasti ▼▲ scegliere il valore e premere ogni volta necessaria il tasto ENTER per confermare la modifica.</p> <p>Se si vuole abbandonare la programmazione e tornare in misura, premere per 3 secondi il tasto ESC.</p>
--	---

METODO EMPIRICO

- Installare la pompa sull'impianto.
 - Farla adescare.
 - A questo punto inserire il tubo di aspirazione in una provetta graduata riempita con gli ml di acqua da dosare. Si consiglia di definire un quantitativo tale che la pompa dosi almeno per 40 sec / 1 minuto.
- Ad esempio:
-300ml per una pompa 20 litri/h; -200ml per una pompa 12litri/h;-100ml per una pompa 6litri/h;-50ml per una pompa 3litri/h; -30ml per una pompa 2litri/h.



Per motivi di sicurezza la pompa deve essere calibrata con acqua

	<p>All'interno del Menu Calibrazione, selezionare con il cursore "Calib. Portata" e premere ENTER.</p> <p>Con i tasti ▼▲ scegliere il valore della quantità di prodotto da aspirare e premere ogni volta necessaria il tasto ENTER per confermare la modifica.</p> <p>Premere ENTER per iniziare a far dosare la pompa.</p> <p>Non appena il contenitore sarà vuoto, premere ENTER per interrompere il dosaggio della pompa.</p> <p>La pompa calcola la portata e la scrive, premere ENTER per confermarla.</p> <p>Se si visualizza il messaggio "Portata Errore" ripetere la calibrazione aumentando o diminuendo la quantità di prodotto.</p> <p>Se si vuole abbandonare la programmazione e tornare in misura, premere per 3 secondi il tasto ESC.</p>
--	---

MENU UTILITÀ

Il menu di **Utilità** permette di programmare il Ritardo di accensione, e permette di ripristinare i parametri di fabbrica della programmazione.

	<p>Premere il tasto ENTER/MENU per 3 secondi per entrare in programmazione.</p> <p>Con il cursore selezionare Utilità e premere ENTER.</p> <p>Posizionare il cursore sulla voce da modificare.</p> <p>Premere ENTER per entrare nel sottomenu e procedere alla modifica.</p> <p>Se si vuole abbandonare la programmazione e tornare in misura, premere per 3 secondi il tasto ESC.</p>
--	---

RITARDO DI ACCENSIONE

CHE COSA E'? Il **Ritardo di Accensione** è il tempo in minuti (da 0-99minuti) che la pompa attende dopo la sua accensione per dosare il prodotto chimico. Durante questo tempo viene visualizzato il messaggio "Ritardo Accens." sul display che si alterna alla scritta del modo di funzionamento e della portata. Durante questo tempo la pompa è disabilitata al dosaggio ma è possibile accedere al menu per modificare parametri e calibrazioni.

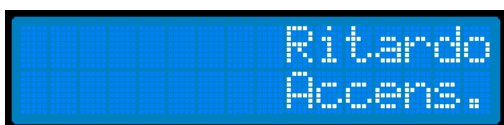

COME PROGRAMMARE IL RITARDO DI ACCENSIONE:

	<p>All'interno del Menu Utilità, selezionare con il cursore "Rit.Acc" e premere ENTER.</p> <p>Inserire con i tasti ▼▲ il valore dei minuti di ritardo desiderato e premere ENTER.</p> <p>Attenzione: la modifica sarà attiva dalla prossima accensione della pompa!</p> <p>Se si vuole abbandonare la programmazione e tornare in misura, premere per 3 secondi il tasto ESC.</p>
---	---

RIPRISTINO PARAMETRI DI PROGRAMMAZIONE

Attenzione : il Ripristino non ha influenza sulla calibrazione della portata, data e ora, la lingua e la password.

	<p>All'interno del Menu Utilità, selezionare con il cursore "Ripristino" e premere ENTER.</p> <p>Con i tasti ▼▲ far comparire "Si" su Conferma. Premere ENTER.</p> <p>Automaticamente la pompa ripristina le regolazioni di fabbrica.</p> <p>Premere per 3 secondi il tasto ESC per uscire dalla programmazione.</p>
--	--

MENU RELÉ (A RICHIESTA)

L'uscita relè segnala la presenza di un allarme. È un contatto privo di tensione. La segnalazione può avvenire con la chiusura del contatto o con l'apertura (default Allarme è N.A). Nel menu relè si decide quali allarmi possono venire segnalati dal relè.

NOTA IMPORTANTE:

Il Livello, Enable e Rottura tubo sono optional. Se sulla vostra pompa non sono presenti non sarà possibile accedere al relativo sottomenu e nel menu comparirà:



	<p>Premere il tasto ENTER/MENU per 3 secondi per entrare in programmazione.</p> <p>Con il cursore selezionare Relè e premere ENTER.</p> <p>Posizionare il cursore sulla voce da modificare. Premere ENTER per entrare nel sottomenu e procedere alla modifica.</p> <p>Se si vuole abbandonare la programmazione e tornare in misura, premere per 3 secondi il tasto ESC.</p>
--	---

ALLARME

	<p>All'interno del Menu Relè, selezionare con il cursore "Allarme" e premere ENTER.</p> <p>Selezionare con i tasti ▼▲ il modo di funzionamento del relè desiderato e premere ENTER.</p> <p>N.A= Normalmente Aperto (valore di default) N.C= Normalmente Chiuso</p> <p>Se si vuole abbandonare la programmazione e tornare in misura, premere per 3 secondi il tasto ESC.</p>
--	---

INCLUDERE / ESCLUDERE IL RITARDO DI ACCENSIONE

	<p>All'interno del Menu Relè, selezionare con il cursore "Rit.Acc" e premere ENTER.</p> <p>Includere o escludere l'allarme con i tasti ▼▲ e premere ENTER.</p> <p>Se si vuole abbandonare la programmazione e tornare in misura, premere per 3 secondi il tasto ESC.</p>
--	---

Per INCLUDERE O ESCLUDERE gli altri allarmi seguire gli stessi passaggi del Ritardo di Accensione.

MENU DOSAGGIO

Il menu **DOSAGGIO** permette di scegliere:
il tipo di dosaggio della pompa: Manuale, mA.

NB: per cambiare tipo di dosaggio va confermato con il tasto **ENTER** almeno un parametro del nuovo dosaggio.

	<p>Premere il tasto ENTER/MENU per 3 secondi per entrare in programmazione.</p> <p>Con il cursore selezionare Dosaggio e premere ENTER.</p> <p>Posizionare il cursore sul tipo di dosaggio da scegliere e premere ENTER per entrare nel sottomenu e procedere alla modifica.</p> <p>Se si vuole abbandonare la programmazione e tornare in misura, premere per 3 secondi il tasto ESC.</p>
--	---

-**Manuale**, la pompa dosa costantemente alla portata programmata. È possibile attivare un dosaggio ciclico con tempo di ritardo Td, Ton e Toff programmabili.

-**mA**, portata proporzionale ai mA ricevuti, range di proporzionalità completamente programmabile.

DOSAGGIO MANUALE

Ci sono 2 tipi di dosaggio Manuale:

- 1) Con il parametro Ciclo disattivo (**Ciclo [dis]**) il dosaggio è costante alla portata definita (%Portata)
- 2) Con il parametro Ciclo attivo (**Ciclo [att]**) il dosaggio è costante alla portata definita (% Portata) ma è anche ciclico con tempi di ON (Ton) e OFF (Toff) programmabili. Inoltre si attiva dopo un ritardo programmabile (Td) all'accensione della pompa oppure al ricevimento del segnale di abilitazione (Enable). Questo ultimo ingresso è un optional e quindi può non essere presente. Vedere schema Connessioni a pag 7. NB: nel caso che l'optional enable sia presente, si può scegliere se attivarlo oppure no nel menu SET UP; pag 9.

All'interno del Menu Dosaggio, selezionare con il cursore "**Manuale**" e premere **ENTER**.

Scegliere con i tasti **▼▲** il parametro da modificare e premere **ENTER**.
In figura a lato sono visibili i parametri di fabbrica con ciclo disattivo e con ciclo attivo.

Td: è il tempo in secondi (da 0-9999sec) che la pompa attende dopo la sua accensione o dopo la ricezione del segnale di enable per dosare il prodotto chimico

Ton: è il tempo in secondi (da 0-9999sec) di dosaggio

Toff: è il tempo in secondi (da 0-9999sec) di stop del dosaggio

Dosaggio Manuale:

- A) Ciclo disattivo
- B) Ciclo attivo

1. **t = t₁**: Istante di accensione della pompa o ricevimento del segnale di enable
2. **t = t₂**: Istante di spegnimento della pompa o interruzione del segnale di enable

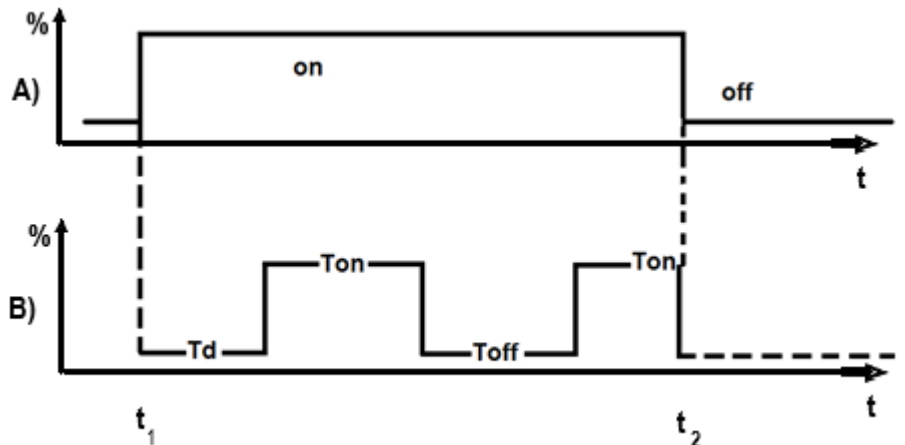

DOSAGGIO mA

Dosaggio proporzionale alla lettura di mA. L'intervallo di proporzionalità e la portata sono programmabili liberamente.

All'interno del Menu Dosaggio, selezionare con il cursore "**mA**" e premere **ENTER**.
In figura a lato sono visibili i parametri di fabbrica.

Scegliere con i tasti **▼▲** il parametro da modificare e premere **ENTER** per entrare nella modifica.

Con i tasti **▼▲** scegliere il valore desiderato e premere ogni volta necessaria il tasto **ENTER** per confermare la modifica.

Se si vuole abbandonare la programmazione e tornare in misura, premere per 3 secondi il tasto **ESC**.

PARAMETRI:

mA Min: valore della corrente minima

% Min: portata della pompa quando l'ingresso supera la corrente minima.

Dos.Min: permette di scegliere se al di sotto della corrente minima la pompa deve dosare **[att]** alla portata **% Min** oppure non deve dosare **[dis]**.

mA Max: valore della corrente massima

% Max: portata della pompa quando in ingresso c'è la corrente massima

Dos.Max: permette di scegliere se al di sopra della corrente massima la pompa deve dosare **[att]** alla portata **% Max** oppure non deve dosare **[dis]**.

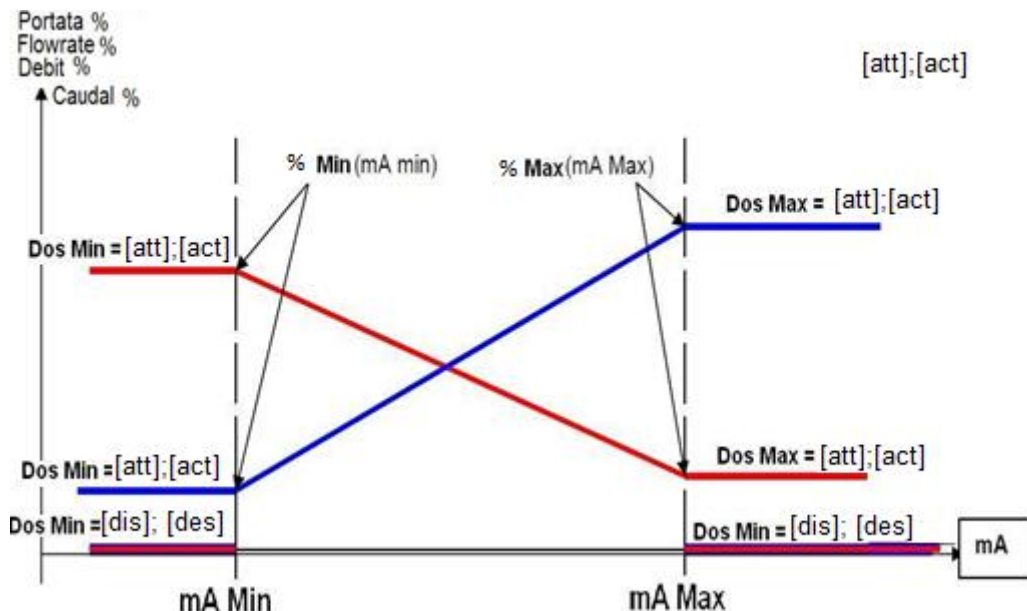

NB: CON I PARAMETRI DI FABBRICA, CON UNA CORRENTE IN INGRESSO DI 4.0mA LA POMPA NON DOSA, CON UNA CORRENTE IN INGRESSO DI 20mA LA POMPA DOSA AL 100% DELLA PORTATA.

DESCRIPTION OF CHARACTERISTICS AND OPERATION

The "MP2-HT mA" dosing pumps series are ideal for the most varied treatments.

They can operate in Manual, mA and the flowrate is adjustable from 10% to 100% of the maximum flowrate. They can adjust the flowrate by varying the rotation speed of the roll holder.

Optionally, these pumps can be equipped with a peristaltic tube break sensor which, in case of chemical leaks, blocks the dosage and they can optionally have a relay output, configurable for the repetition of an alarm (for example: flow alarm, level alarm, peristaltic hose breakage alarm, etc).

FRONT PANEL DESCRIPTION

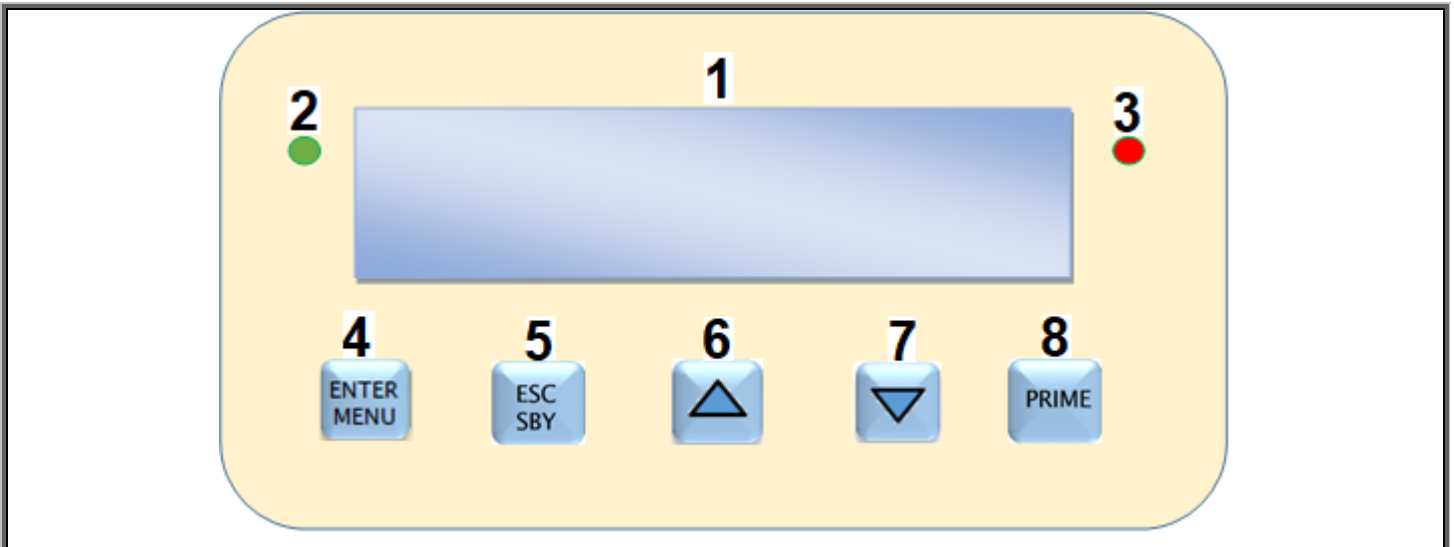

- | | |
|--|--|
| <p>1. Display LCD 16 x 2 backlight</p> <p>2. Green Led: ▪ fix = PUMP ON
▪ blinking = PUMP IN ALARM</p> <p>3. Red Led: indicates the injections of chemical dosing</p> <p>4. ENTER/MENU button : ▪ allows to enter in programming
▪ saves the changes</p> | <p>5. ESC/SBY button: ▪ allows to exit from the menu
▪ puts the pump in stand_by mode</p> <p>6/7. ▲ ▼ buttons : ▪ allow to navigate through the menu
▪ allow to modify the parameters values</p> <p>8. Prime button: ▪ allows to prime the pump</p> |
|--|--|

GENERAL FUNCTIONS

- VISUALIZATION OF DOSING TYPE
- REAL TIME FLOW **RATE%** VISUALIZATION
- 2 POSSIBLE **TYPES OF DOSING**: MANUAL, mA
- **MENU IN 4 LANGUAGES**: ITALIAN, ENGLISH, FRENCH, SPANISH
- POSSIBILITY TO INSERT A **PASSWORD**
- **DELAY ON SWITCHING ON**
- **PRIME BUTTON**
- **ALARM RELAY** (DRY CONTACT) OUTPUT FOR REPEATING ALARMS
- **RESTORATION** OF DEFAULT PARAMETERS
- DOSAGE STOP (**STAND_BY**)
- CONTROL OF PRODUCT END **LEVEL**
- **ENABLE** INPUT SIGNAL
- **HOSE BREAKAGE** SENSOR

CONNECTIONS

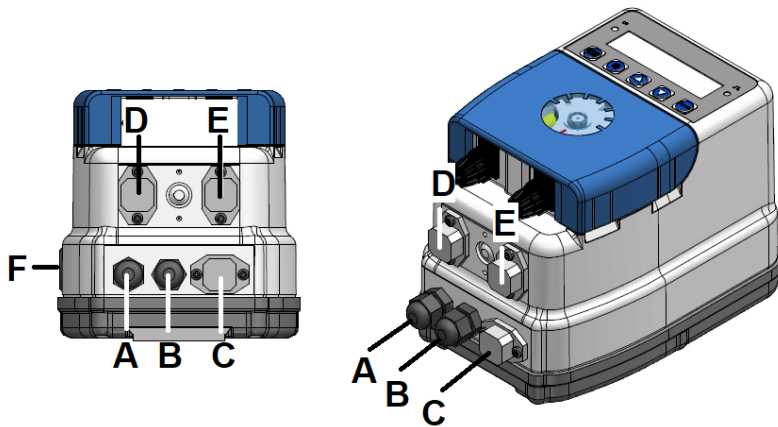

- A** - Power cable, 90-250V-50-60Hz
- B** - Enable input (dosing consent) (110Vac; 230Vac; upon request 24V). **OPTIONAL**
- C** - **Alarm** output connector (3 and 4 contacts). (5A 250Vca/30Vdc) **NORMALLY OPEN. OPTIONAL.**
- D** - Level probe connector (3 and 4 contacts). **OPTIONAL.**
- E** - Connector for mA input (contacts 3 (+) and 4 (-)).
- F** - ON_OFF switch. **OPTIONAL**

DEFAULT SETTINGS

PASSWORD = Not programmed
Delay On: 0 minutes
Enable (optional): active
Broken Hose (optional): active

- Dosing: **mA**
- mA Min: **4.0mA**
- % Min: **10%**
- Dos.Min: **deactive**
- mA Max: **20.0mA**
- % Max: **100%**
- Dos.Max: **active**
-

DEFAULT SETTINGS RESTORE



Keep pushing for 3 seconds the **ENTER / MENU** button to enter into the programming menu.

Move the cursor > to Utility by pressing ▼. Push **ENTER** button to enter the submenu.

Push ▼ button to move the cursor to "Reset". Push **ENTER** button to confirm.

By pushing the ▼ button choose "YES" to confirm and push **ENTER** button.

Automatically the pump restores the factory settings. Press the **ESC** button for 3 seconds to exit programming.

DISPLAY IN DIFFERENT DOSING

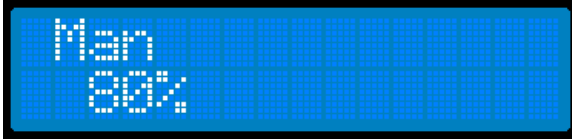

- Dosing: **Manual** with cycle deactive;
- The pump is dosing with 80% Flowrate

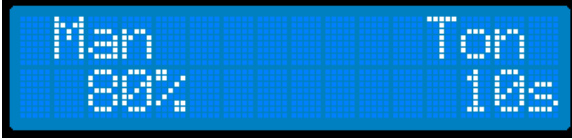

- Dosing: **Manual** with cycle active;
- The pump is dosing with 80% Flowrate during Ton=10 second

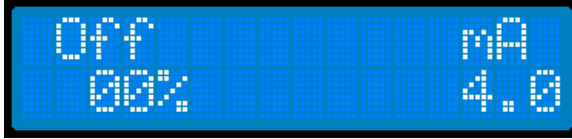

- Dosing: **mA**
- The pump doesn't dose, it is receiving 4 mA from the input

STAND BY (STOP)

ESC
SBY

3sec

Man
00%

↔

Man
00%
Stby

Keep pushing **ESC/SBY** button for 3 seconds during the functioning to put the pump in stand by mode:

- 1) The pump stops dosing
- 2) Green on led blinks
- 3) The display shows alternatively "**Stby**" and the type of dosing (flowrate is 0%)

Push again the **ESC/SBY** button to return the pump to the programmed functioning.

PRIME BUTTON

PRIME

Prime
25%

Push the **PRIME** button shortly during the functioning to put the pump in Prime status:

- 1) the pump doses at 25% of maximum flowrate
- 2) the green LED is lit fix
- 3) the red LED flashes
- 4) display shows "Prime 25%"

Push again **PRIME** button to return the pump to the operating state.

NOTE: keeping pressed the PRIME button the pump will dose at 80% of the maximum flowrate and the display will show "Prime 80%".

LEVEL PROBE CONTROL (OPTIONAL)

Off
00%
mA
4.0

↔

Off
00%
Level

The closing of the level input dry contact will cause:

- 1) the dosage stops
- 2) the green ON led blinks
- 3) the display shows alternatively "**Level**" and the actual dosing mode (flowrate is 0%).

When the level contact gets opened again, the pump returns to working mode compatible with the actual inputs.

STRUCTURE OF THE MAIN MENU

	<p>Press the ENTER / MENU button for 3 seconds to enter programming.</p> <p>Use the ▼ button to move the cursor to the relevant submenus. Press ENTER to enter the submenu.</p> <p>If you want to esc programming and return to measurement, press the ESC button for 3 seconds.</p>
--	--

The **Set up** menu allows choosing:

The Language, the display contrast, the safety Password, the activation or deactivation of the Enable input (dosing enable), the activation or deactivation of the peristaltic hose breaking sensor.

The **Dosing** menu allows choosing:

the type of dosing among Manual, mA.

The **Calibration** menu allows:

To calibrate the flow rate or select it from the label on the pump box.

The **Utility** menu allows choosing:

to schedule or not the Delay On and to Restore the factory programming parameters.

The **Relay** menu allows choosing:

the operation of the alarm relay (N.O or N.C), whether to include or exclude from the relay signal the various types of alarm (Delay On, Level, Enable, Brok.Hose, Stby).

MENU SET UP

IMPORTANT NOTE:

Enable and Brok. Hose sensor are optional. If on your pump they are not present you can not access the respective submenus and in the menu will appear:



	<p>Press the ENTER/MENU button for 3 seconds to enter programming.</p> <p>Select by the cursor the menu SET up and press ENTER.</p> <p>Use the ▼▲ buttons to move the cursor to the submenus. Press ENTER to enter the submenu.</p> <p>If you want to esc programming and return to measurement, press the ESC button for 3 seconds.</p>
--	--

LANGUAGE

	<p>In the Set up menu, select "Language" with the cursor and press ENTER.</p> <p>Choose "English" with the ▼ ▲ keys and press Enter.</p> <p>If you want to esc programming and return to measurement, press the ESC button for 3 seconds.</p>
--	---

NB: the language is not restored when the pump is reset (Utility menu).

PASSWORD

The password protects the modification of the **Dosing**, **Utility** and **Relay** menus. It does not block **Calibration** and **Set up**. By default the password is not present and it is therefore possible to access all the programming.

First definition of the password:

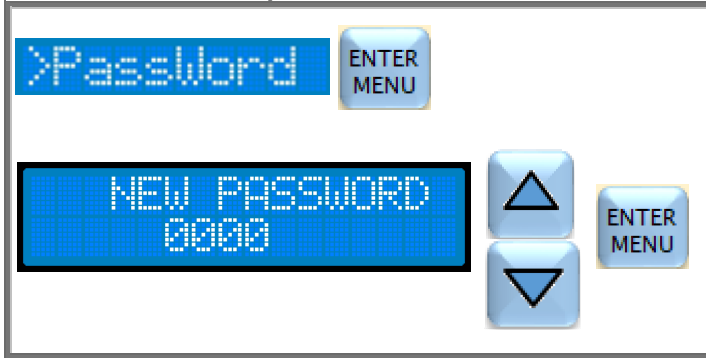
	<p>In the Set up menu, select "Password" by the cursor and press ENTER.</p> <p>Enter the password digit by digit selecting the number by ▼ ▲ button and pressing ENTER.</p> <p>After the selection of the 4th digit, press ENTER to save the password. <i>Take note of it carefully to not forget it. <u>If it is not possible to remember the password call the Customer Service Assistance.</u></i></p> <p>To esc programming and return to measurement, press the ESC button for 3 seconds.</p>
--	--

Change password:

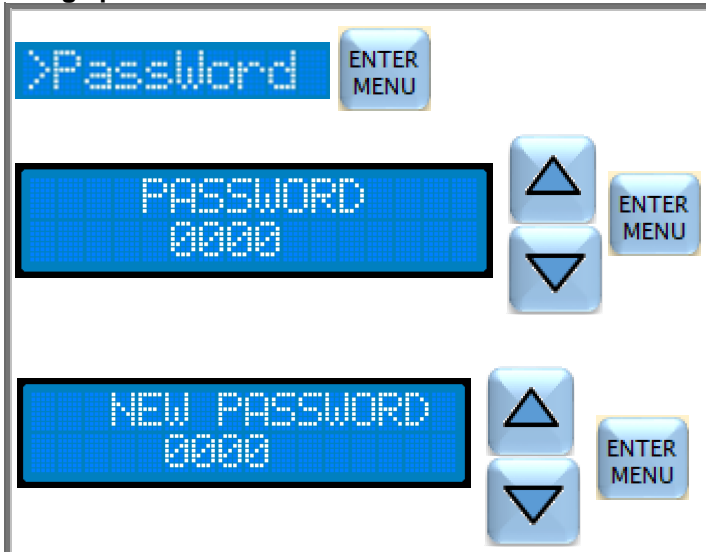
	<p>In the Set up menu, select "Password" by the cursor and press ENTER.</p> <p>Enter the old password digit by digit selecting the digit by ▼ ▲ buttons and press ENTER.</p> <p>After entering the 4th digit, pressing ENTER it is possible to define the new password.</p> <p>Enter the new password digit by digit selecting the digit by ▼ ▲ buttons and press ENTER.</p> <p>After entering the 4th digit, press ENTER to save the new password.</p> <p><i>Take note of it carefully to not forget it. <u>If it is not possible to remember it, call the Customer Service Assistance.</u></i></p> <p>If you want to esc the programming and return to measurement, press the ESC button for 3 seconds.</p>
---	--

ENABLE (OPTIONAL)

The enable input (230Vac-110Vac) gives to the pump the consent to dose. In swimming pool plants this input is connected in parallel with the recirculation pump power supply so that if the filtration is stopped the pump can not dose. In order not to damage the electronic board, do not connect the enable directly in parallel with the recirculation pump power supply, but always use a contactor / relay (see installation manual). In the case that your pump has the enable option (see position B page 18: CONNECTIONS), you can choose to activate this input or not as follows:

	<p>In the Set up menu, select "Enable" by the cursor and press ENTER.</p> <p>Use the ▼ ▲ buttons to select whether to enable ("active") or disable (deactive) this input and press ENTER.</p> <p>If you want to esc programming and return to measurement, press ESC for 3 seconds.</p>
--	---

If your pump has not included the enable option then it will not be possible to access the "Enable" submenu and the flashing message "DEA" will appear:



BROKEN HOSE (OPTIONAL)

What is that?

It is a sensor that detects if the peristaltic tube is torn and leaves the chemical to come out.

When the broken hose alarm starts, it stops the dosage and the green led flashes and the display shows "broken hose".



Before any intervention, disconnect the pump from the mains supply!



During the operation always use the personal protections recommended by the warnings of use of the dosed chemical. For example, use gloves, apron, glasses, etc ...

The peristaltic hose must therefore be changed. The sensor area inside the pump housing must also be rinsed and carefully dried. See the explanatory image above. To esc from this alarm push the ESC button.

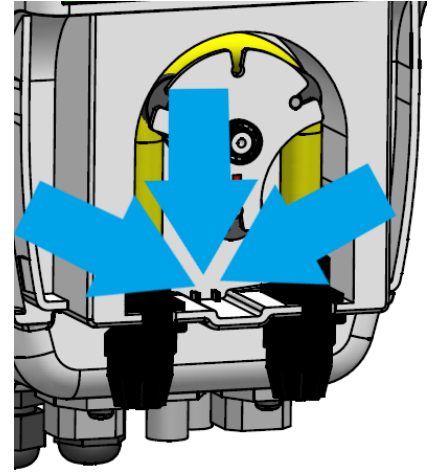

Once the operation has been carried out safely, the pump can be restarted.

NB: IF THE PUMP IS SWITCHED OFF DURING THE BROKEN HOSE ALARM, WHEN IT WILL BE SWITCHED ON AGAIN IT WILL REMEMBER THE PREVIOUS ALARM. TO EXIT FROM THE BROKEN HOSE ALARM SHORTLY PUSH THE ESC BUTTON.

In the case that your pump has the "Broken Hose" option, you can choose to activate this input or not.

	<p>In the Set up menu, select "Brok.Hose" by the cursor and press ENTER.</p> <p>Use the ▼ ▲ buttons to select whether to enable ("active") or disable (deactivate) this input and press ENTER.</p> <p>If you want to esc programming and return to measurement, press ESC for 3 seconds</p>
---	--

If your pump has not the Broken Hose option then it will not be possible to access the "Brok.Hose" submenu and the flashing message "DEA" will appear:



CALIBRATION MENU (of flowrate)

The definition of the flowrate of the pump is not necessary for the Manual and mA dosages.

In this pump model the empirical way is useful for the precise determination of the flowrate in working conditions.

The definition of the flowrate (ie the liters / hour of product dosed by the pump) can be carried out in 2 ways.

A fast way (Table Flowrate) by reading the identification label on the side of the pump.

An empirical and more accurate way (Calib. Flowrate) that takes into account the working conditions of the pump (tube and motor run-in for example).

ALL PUMPS ARE PRECALIBRATED by FACTORY WITH TABLE FLOWRATE. The flowrate is not reset when the pump is reset (Utility menu)

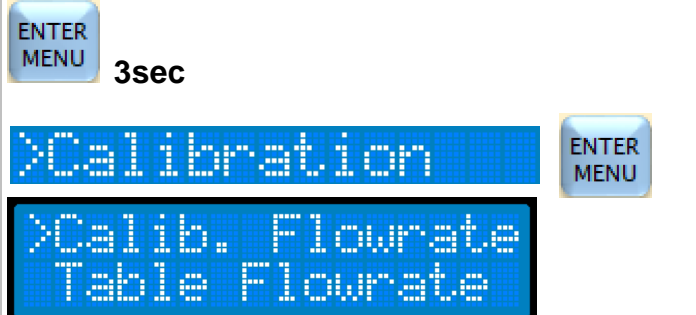
	<p>Press the ENTER / MENU button for 3 seconds to enter programming.</p> <p>Use the cursor to select Calibration and press ENTER.</p> <p>Position the cursor on the type of calibration you want to do. Press ENTER to enter the submenu and proceed with the change.</p> <p>If you want to esc programming and return to measurement, press ESC for 3 seconds.</p>
--	--

FAST WAY (TABLE FLOWRATE):

Read the pump model that you have on the label applied on the pump (see figure on the side) and write it on the "Table Flowrate" parameter as follows:

S/N: XXXXXXXXXXXX
 Type: XXXXXXXXXXXX
 Code: XXXXXXXXXXXX



90-250Vac 50/60Hz 20W

6l/h 1bar SANT



	<p>In the Calibration Menu, select with cursor "Table Flowrate" and press ENTER.</p> <p>Read the flowrate on the pump label and use the ▼▲ buttons to select the value and press the ENTER button whenever necessary to confirm the change.</p> <p>If you want to esc programming and return to measurement, press ESC for 3 seconds.</p>
--	---

EMPIRICAL WAY

- Install the pump on the system.
- Make her prime.

- Insert the suction tube into a measuring cup filled with the ml of water to dose. It is advisable to define a quantity such that the pump doses for at least 40 sec / 1 minute. For example:

-300ml for a 20 liters / h pump; -200ml for a 12litre / h pump; -100ml for a 6litre / h pump; -50ml for a 3litre / h pump; -30ml for a 2litre / h pump.

For safety reasons, the pump must be calibrated with water

	<p>In the Calibration Menu, select with cursor "Calib. Flowrate" and press ENTER.</p> <p>With the ▼▲ buttons choose the value of the quantity of product to aspirate and press the ENTER button whenever necessary to confirm the change.</p> <p>Press ENTER to start dosing.</p> <p>As soon as the container is empty, press ENTER to stop the pump dosing.</p> <p>The pump calculates the flowrate and writes it. Press ENTER to confirm it.</p> <p>If the display shows "Flowrate Error" message repeat the calibration by increasing or decreasing the quantity of product.</p> <p>If you want to esc programming and return to measurement, press ESC for 3 seconds.</p>
--	--

MENU UTILITY

The Utility menu allows you to program the Delay On and to restore the factory programming of the parameters.

	<p>Press the ENTER/MENU button for 3 seconds to enter programming.</p> <p>Select by the cursor the menu Utility and press ENTER.</p> <p>Use the ▼▲ buttons to move the cursor to the submenus. Press ENTER to enter the submenu.</p> <p>If you want to esc programming and return to measurement, press the ESC button for 3 seconds.</p>
--	---

DELAY ON

WHAT IS IT? The Delay On is the time in minutes (from 0-99minutes) that the pump waits after its power on to dose the chemical. During this time, the display shows the message "Delay On" that alternates with the writing of the operating mode and the flow rate. During this time, the pump cannot dose but it is possible to program parameters and calibrations.

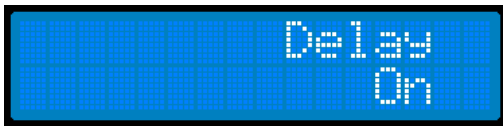

HOW TO PROGRAMM THE DELAY ON:

	<p>In the Utility menu, select "Delay On" by the cursor and press ENTER.</p> <p>Use the ▼▲ buttons to select the desired minutes of delay and press ENTER.</p> <p>Attention: the change will be active from the next power on of the pump!</p> <p>If you want to esc programming and return to measurement, press ESC for 3 seconds.</p>
--	---

RESET PROGRAMMING PARAMETERS

Attention: the Reset has no influence on the Calibration of the flowrate, Date and hour, Language, Password

	<p>In the Utility Menu, select "Reset" by the cursor and press ENTER.</p> <p>Use the ▼▲ keys to display "Yes" on Confirm. Press ENTER.</p> <p>Automatically the pump restores the factory settings. Press the ESC button for 3 seconds to exit programming.</p>
--	--

MENU RELAY (OPTIONAL)

The relay output indicates the presence of an alarm. It is a dry contact. The relay reports an alarm by closing the contact or by opening it (default is N.O). See the following paragraph, "Alarm". In the Relay menu it is possible to decide which alarms can be reported by the relay.

IMPORTANT NOTE:

Level, Enable and Brok. Hose sensor are optional. If on your pump they are not present you can not access the respective submenus and in the menu will appear:





Press the **ENTER/MENU** button for 3 seconds to enter programming.

Select by the cursor the menu **Relay** and press **ENTER**.

Use the **▼▲** buttons to move the cursor to the submenus. Press **ENTER** to enter the submenu.

If you want to esc programming and return to measurement, press the **ESC** button for 3 seconds.

ALARM

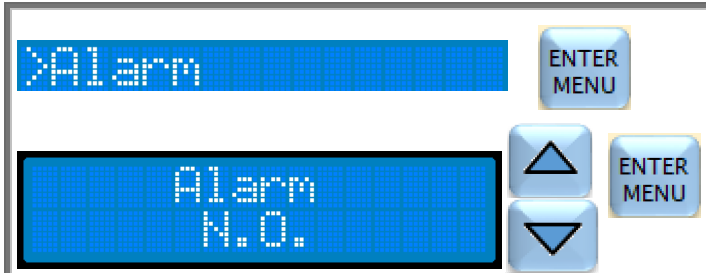

In the menu **Relay**, select by the cursor "Alarm" and press **ENTER**.

Select the desired operating mode of the relay with the **▼▲** buttons and press **ENTER**.

N.O = Normally Open (default value)

N.C = Normally Closed

If you want to esc programming and return to measurement, press the ESC key for 3 seconds.

DELAY ON



In the menu **Relay**, select by the cursor "Delay On" and press **ENTER**.

Include or exclude this alarm by **▼▲** buttons and press **ENTER**.

If you want to esc programming and return to measurement, press the ESC key for 3 seconds.

To INCLUDE OR EXCLUDE the other alarms follow the same steps of Delay On here above.

MENU DOSING

The **DOSING** menu allows you to choose the type of pump dosing:

Manual, mA.

NB: to change the type of dosing, confirm with the **ENTER** button at least one parameter of the new dosing mode.



Press the **ENTER/MENU** button for 3 seconds to enter programming.

Select by the cursor the menu **Dosing** and press **ENTER**.

Position the cursor on the type of dosage to choose and press **ENTER** to enter to the submenu and proceed with the modification.

If you want to esc programming and return to measurement, press the **ESC** button for 3 seconds.

-**Manual**, the pump doses constantly at the programmed flowrate. It is possible to activate a cyclic dosage with programmable time of delay, time of dosing (Ton) and time of not dosing (Toff).

-**mA**, flowrate proportional to the mA current received from the input. Fully programmable range of proportionality.

MANUAL DOSING

There are 2 manual dosage types:

- 1) With the Cycle parameter deactive (**Cycle [dea]**) the dosage is constant at the defined flowrate (% Flowrate)
- 2) With the Cycle parameter active (**Cycle [act]**) the dosage is constant at the defined flowrate (% Flowrate) but is also cyclical with programmable ON (Ton) and OFF (Toff) times. Furthermore, the dosing can be activated after a programmable delay (Td) when the pump is switched on or when the enable signal is received. The enable input is optional and therefore may not be present. See the Connections diagram on page 18. NB: if the optional enable is present, you can choose whether to activate it or not in the SET UP menu; page 20.

In the menu **Dosing**, select by the cursor "Manual" and press **ENTER**.

Use the **▼▲** buttons to select the parameter to be changed and press **ENTER**.
In the figure on the left you can see the factory parameters with cycle disabled and with active cycle.

Td: this is the time in seconds (from 0-9999sec) that the pump waits before dosing the chemical after its switching on or after receiving the enable signal.

Ton: this is the time in seconds (from 0-9999sec) of dosing

Toff: this is the time in seconds (from 0-9999sec) of stop dosing.

Manual dosing:

- A) Deactive cycle
- B) Active cycle

1. $t = t_1$: Istant of switching on of the pump or istant of receiving the enable signal
2. $t = t_2$: Istant of switching off of the pump or interruption of the enable signal

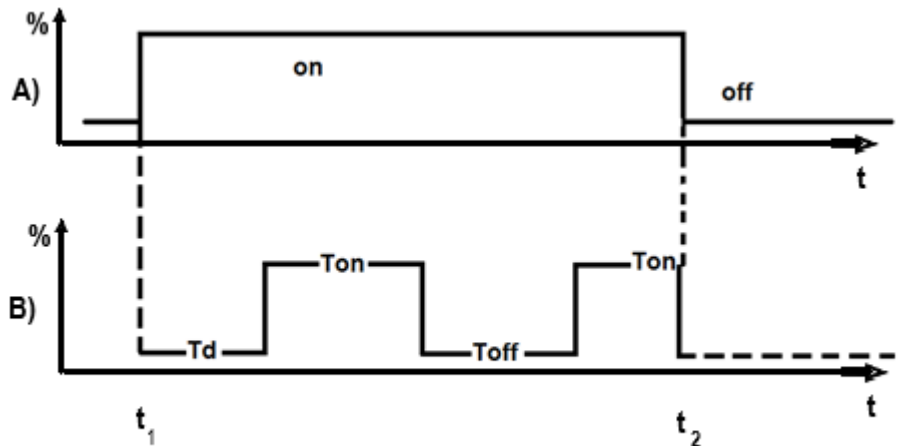

mA DOSING

This dosing is proportional to the mA current received from the input. The proportionality range and the flowrate can be freely programmed.

In the menu **Dosing**, select by the cursor "mA" and press **ENTER**.

In the figure on the left you can see the factory parameters.

Use the **▼▲** buttons to select the parameter to be changed and press **ENTER**.

Use the **▼▲** buttons to select the desired value and press **ENTER** whenever necessary to confirm the change.

If you want to esc programming and return to measurement, press the **ESC** button for 3 seconds.

PARAMETERS:

mA Min: minimum mA current value

% Min: flowrate of the pump when the input exceeds mA Min

Dos.Min: allows to choose if, when the input mA current is less than the minimum mA current, the pump must dose **[act]** at the **% Min** flowrate or it must not dose **[dea]**

mA Max: maximum mA current value

% Max: flowrate of the pump when the input current is equal to mA Max

Dos.Max: allows to choose if, when the input mA current is greater than mA Max, the pump must dose **[act]** at the **% Max** flowrate or it must not dose **[dea]**

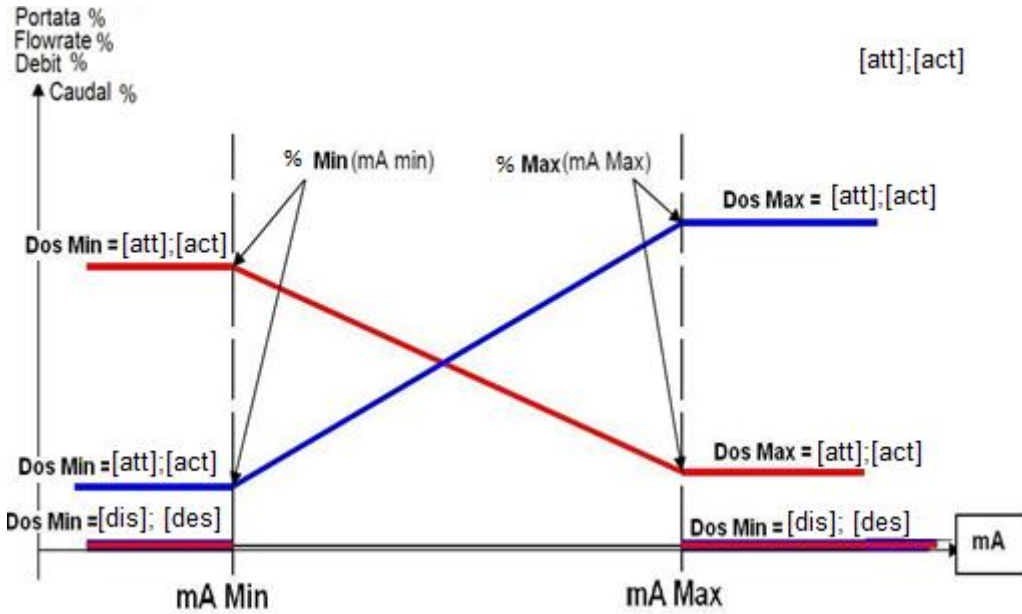

NB: WITH FACTORY SETTINGS, WHEN IN THE INPUT THERE IS A CURRENT OF 4.0mA THE PUMP DOES NOT DOSE; WHEN IN THE INPUT THERE IS A CURRENT OF 20mA THE PUMP DOES AT 100% OF THE FLOWRATE.

DESCRIPTION DES CARACTERISTIQUES ET DU FONCTIONNEMENT

Les pompes doseuses de la série "MP2-HT mA" sont idéales pour le dosage dans les applications les plus variées. Elles peuvent fonctionner en mode Manuelle, mA et le débit est réglable de 10% à 100% de la capacité maximale. Ces pompes régulent le débit en faisant varier la vitesse de rotation du porte-rouleau. Elles peuvent éventuellement héberger un capteur de rupture de tube péristaltique qui, en cas de pertes du produit chimique, bloque le dosage et éventuellement une sortie relais configurable pour la répétition d'une alarme (par exemple: alarme de niveau, rupture de tube péristaltique, etc.).

DESCRIPTION DU PANNEAU AVANT

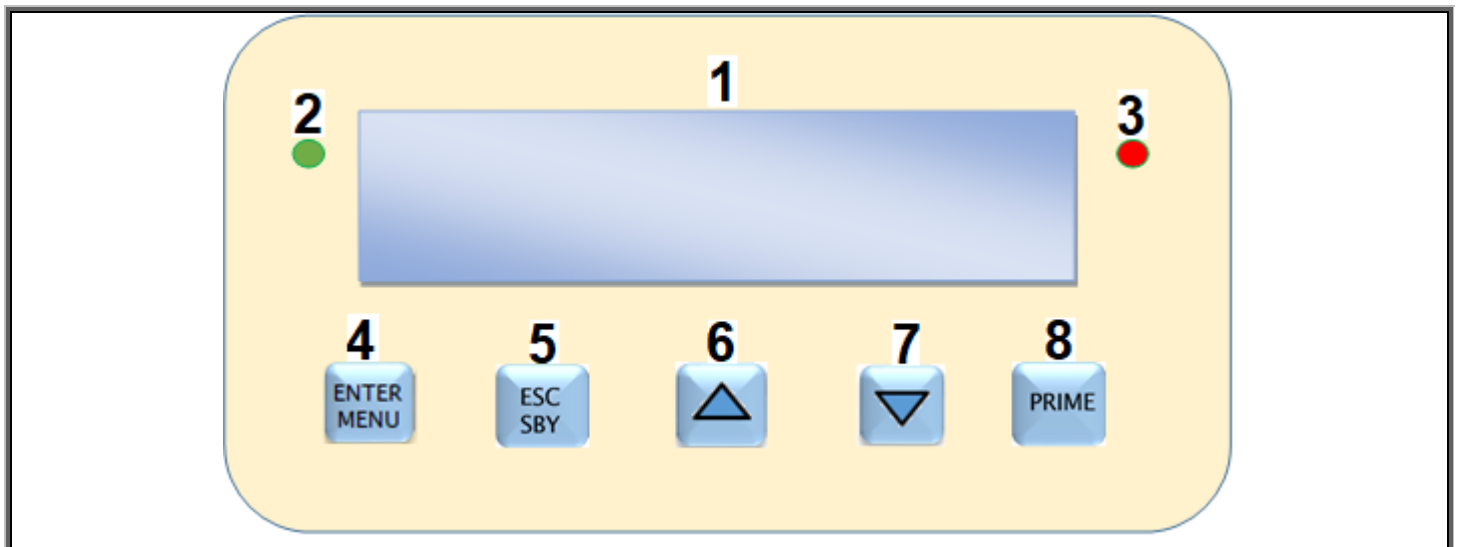

- | | |
|--|--|
| <p>1. Ecran LCD rétro-éclairé 16 x 2 caractères</p> <p>2. LED verte: ▪ fixe = PUMP ON
▪ clignotant = POMPE D'ALARME</p> <p>3. LED rouge: indique les injections du produit chimique</p> <p>4. Touche Entrée / Menu: ▪ entre la programmation
▪ Enregistrer / confirmer les modifications</p> | <p>5. Touche ESC / SBY: ▪ quitte le menu
▪ met la pompe en Stand by</p> <p>6/7 Bouton ▲ ▼: ▪ Naviguer dans le menu
▪ Changer la valeur des paramètres</p> <p>8. Touche PRIME: ▪ amorce la pompe</p> |
|--|--|

FONCTIONS GÉNÉRALES:

- AFFICHAGE DU TYPE DE DOSAGE
- RAPPORT DU **DÉBIT** % INSTANTANÉ PAR INSTANT
- 2 TYPES D'OPÉRATIONS POSSIBLES: **MANUELLE, mA**
- MENU EN 4 LANGUES: **ITALIEN, ANGLAIS, FRANÇAIS, ESPAGNOL**
- **MOT DE PASSE**
- **RETARD D'ALLUMAGE**
- **BOUTON PRIME**
- LE **RELAIS** D'ALARME (CONTACT SANS TENSION) EST UNE SORTIE POUR LA REPETITION DES ALARMES
- **RESTAURATION** DES PARAMETRES
- ARRET DE DOSAGE (**STAND_BY**)
- CONTRÔLE DE LA FIN DU PRODUIT CHIMIQUE
- SIGNAL D'ENTREE POUR LE CONSENTEMENT DU DOSAGE
- CAPTEUR DE RUPTURE DE TUBE

CONNEXIONS

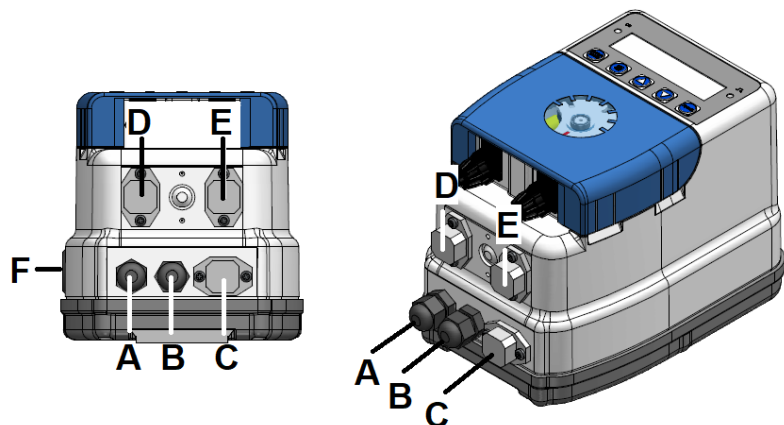

A - est le câble d'alimentation, 90-250V-50-60Hz

B - est l'entrée de consentement à dosage (110Vac; 230Vac; 24V sur demande). **EN OPTION.**

C - est le connecteur de sortie de relais pour les alarmes (contacts 3 et 4). (5A 250Vca/30Vdc). NORMALEMENT OUVERT. **EN OPTION**

D - est le connecteur de la sonde de niveau (contacts 3 et 4). **EN OPTION.**

E - est le connecteur pour l'entrée mA (contacts 3 (+) et 4 (-))

F - est l'interrupteur On / Off (1/0). **EN OPTION**

REGLAGES PAR DEFAUT

PASSWORD = NON INSÉRÉ

Retard d'allumage: 0 minute

Enable (optionnel): actif

Rupture Tube (optionnel): actif

- Dosage: **mA**
- mA Min: **4.0mA**
- % Min: **10%**
- Dos.Min: **des**
- mA Max: **20.0mA**
- % Max: **100%**
- Dos.Max: **act**

RESTAURATION DES PARAMETRES D'USINE

ENTER MENU

3sec



>Utilitaire

ENTER MENU



>Reset

ENTER MENU



Reset Parametres
Confirme OUI

ENTER MENU

Appuyez sur le bouton **ENTER / MENU** pendant 3 secondes pour entrer en programmation.

Utilisez la touche ▼ pour déplacer le curseur sur "**Utilitaire**". Appuyez sur **ENTER** pour entrer dans le sous-menu.

Appuyez sur le bouton ▼ pour déplacer le curseur sur "**Reset**". Appuyez sur **ENTER** pour entrer.

Avec la touche ▼ affichez "**Oui**" sur Confirme. Appuyez sur **ENTER**.

La pompe rétablit automatiquement les réglages d'usine. Appuyez sur la touche **ESC** pendant 3 secondes pour quitter la programmation.

AFFICHAGE DANS DIFFÉRENTS TYPES DE DOSAGE

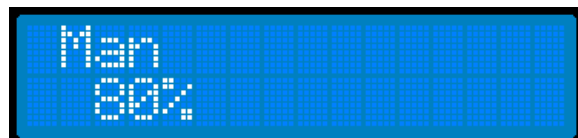

→ Dosage: manuelle avec cycle désactivé;

→ La pompe est en train de doser avec une capacité de 80%

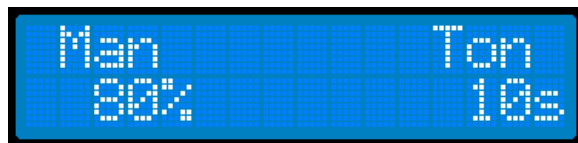

→ Dosage: manuelle avec cycle actif;

→ La pompe est en train de doser avec un débit de 80% pour une Ton de 10 secondes

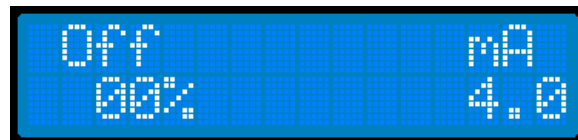

→ Dosage: mA

→ La pompe ne dose pas. Elle reçoit une entrée de 4 mA

STAND BY (STOP)

Une pression prolongée sur le bouton **ESC / SBY** pendant le fonctionnement met la pompe en modalité stand by/Stop:

- 1) LE DOSAGE CESSE
- 2) LED vertes clignotent
- 3) L'écran affiche en alternance "**Stby**" et le type de dosage et le débit%

Appuyant sur le bouton **ESC / SBY** la pompe retourne dans l'état de fonctionnement.

BOUTON PRIME

En appuyant brièvement sur la touche **PRIME** pendant le fonctionnement, la pompe passe en état Prime (amorçage):

- 1) La pompe dose à 25%
- 2) LED verte fixe ; La LED rouge clignote
- 3) L'affichage indique "Prime 25%"

En appuyant à nouveau sur la touche **PRIME**, la pompe revient à l'état de fonctionnement.

NB: Si la pression sur le bouton PRIME est prolongée la pompe dosera à 80% du débit maximal et l'écran affichera "Prime 80%".

CONTRÔLE DU NIVEAU (OPTIONNEL)

La fermeture du contact de niveau provoque:

- 1) L'arrêt du dosage
- 2) Le clignotement de la LED verte on
- 3) L'écran affiche alternativement le message "**Niveau**" et le type de dosage et le débit%

La réouverture du contact de niveau reconduit la pompe dans l'état de fonctionnement.

STRUCTURE DU MENU PRINCIPAL

	<p>Appuyez sur le bouton ENTER / MENU pendant 3 secondes pour entrer en programmation.</p> <p>Avec la touche ▼ déplacer le curseur sur le sous-menu d'intérêt. Appuyez sur ENTER pour entrer dans le sous-menu.</p> <p>Appuyez sur la touche ESC pendant 3 secondes pour quitter la programmation.</p>
--	---

Le menu **Set up** permet:

choisir la langue, le contraste de l'affichage, le mot de passe de sécurité, activer ou désactiver l'entrée Enable (activation du dosage), le capteur de rupture du tube péristaltique.

Le menu **Dosage** permet:

choisir le type de dosage entre Manuelle, mA.

Le menu **Étalonnage** permet:

Étalonner le débit ou la sélectionner sur l'étiquette située sur le corps de la pompe.

Le menu **Utilitaire** permet:

choisir de programmer ou pas le délai d'allumage et rétablir les paramètres d'usine de la programmation.

Le menu **Relais** permet:

choisir le fonctionnement du relais d'alarme (N.O ou N.F) et inclure ou exclure les différents types d'alarme (délai d'allumage, Stand by, Niveau, Enable, Rupture de tube).

MENU SET UP

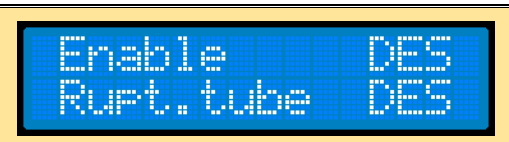
<p>NOTE IMPORTANT: Les Enable et Rupture de tube sont optionnels. Si dans votre pompe ils ne sont pas présent, vous ne pourrez pas accéder aux sous-menus appropriés et dans le menu apparaîtra :</p>	
--	---

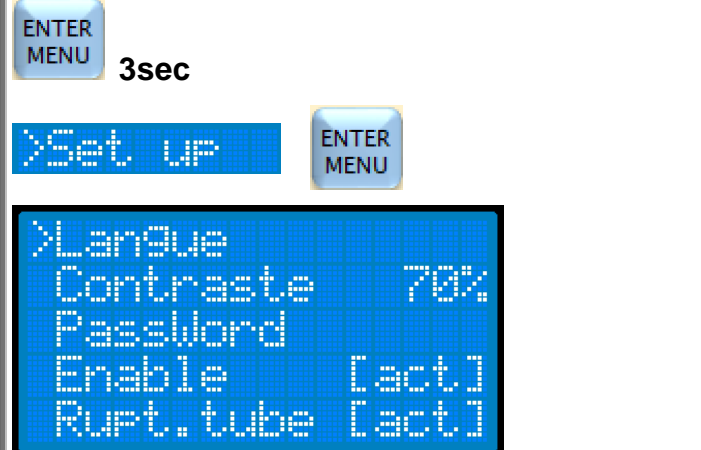
	<p>Appuyez sur le bouton ENTER / MENU pendant 3 secondes pour entrer en programmation.</p> <p>Utilisez la touche ▼ pour déplacer le curseur sur "Set up". Appuyez sur ENTER pour entrer dans le sous-menu.</p> <p>Positionnez le curseur sur l'élément à modifier. Appuyez sur ENTER pour accéder au sous-menu et procéder au changement.</p> <p>Appuyez sur la touche ESC pendant 3 secondes pour quitter la programmation.</p>
--	---

LANGUE

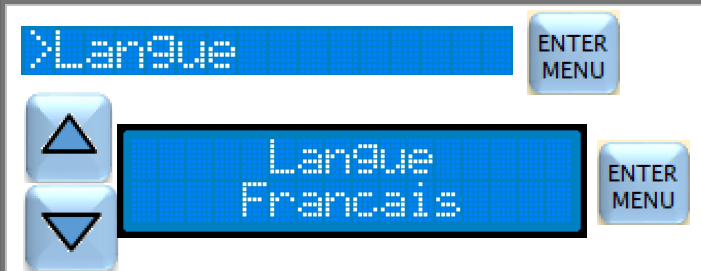
	<p>Dans le menu Set up, sélectionnez "Langue" avec le curseur et appuyez sur ENTER.</p> <p>Choisir « Français » avec les touches ▼ ▲ et appuyez sur ENTER.</p> <p>Appuyez sur la touche ESC pendant 3 secondes pour quitter la programmation.</p>
--	---

NB: la langue n'est pas rétablie lors de la réinitialisation de la pompe (menu **Utilitaire**).

PASSWORD

Le mot de passe (Password) protège la modification des menus **Dosage**, **Utilitaires** et **Relais**. Il ne bloque pas l'**Etalonnage** et le **Set up**.

Par défaut, le mot de passe n'est pas présent et il est donc possible d'accéder à toute la programmation.

Première définition du mot de passe:

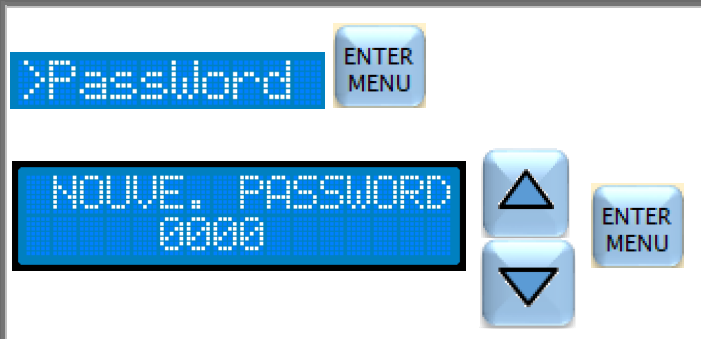
	<p>Dans le menu Set up, sélectionnez "Password" avec le curseur et appuyez sur ENTER.</p> <p>Cela donne accès à la définition chiffre par chiffre du mot de passe. Sélectionnez le chiffre avec les touches ▼ ▲ et appuyez sur ENTER pour confirmer.</p> <p>Après avoir défini le 4ème chiffre, appuyez sur ENTER pour enregistrer le mot de passe. Prenez note pour ne pas l'oublier. Si vous oubliez, <u>appelez le service clientèle</u>.</p> <p>Appuyez sur la touche ESC pendant 3 secondes pour quitter la programmation..</p>
--	---

Changement de mot de passe:

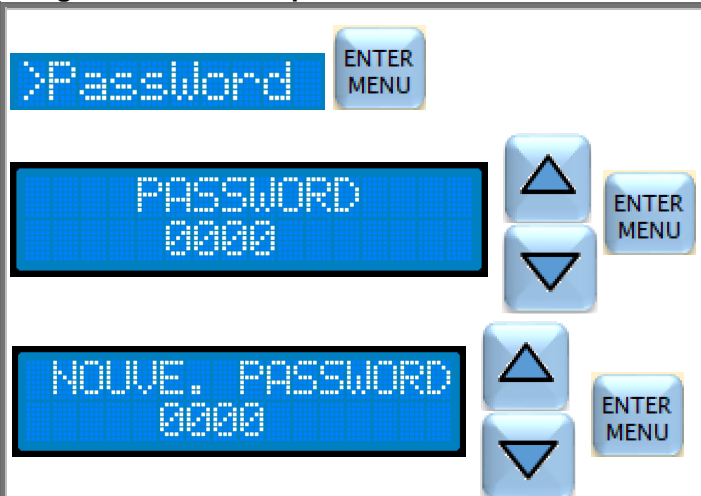
	<p>Dans le menu Set up, sélectionnez "Password" avec le curseur et appuyez sur ENTER.</p> <p>Entrez l'ancien mot de passe chiffre par chiffre. Sélectionnez le chiffre avec les touches ▼ ▲ et appuyez sur ENTER.</p> <p>Après avoir écrit le 4ème chiffre, appuyez sur ENTER pour passer à la définition du nouveau mot de passe.</p> <p>Entrez le nouveau mot de passe chiffre par chiffre. Sélectionnez le chiffre avec les touches ▼ ▲ et appuyez sur ENTER.</p> <p>Après avoir écrit le 4ème chiffre, appuyez sur ENTER pour enregistrer le nouveau mot de passe.</p> <p>Prenez note pour ne pas l'oublier. <u>Si vous oubliez, appelez le service clientèle</u>.</p> <p>Appuyez sur la touche ESC pendant 3 secondes pour quitter la programmation..</p>
---	---

ENABLE (OPTIONNEL)

L'entrée de Enable est une entrée (230Vac-115Vac) qui sert à activer la pompe au dosage. Dans les piscines, cette entrée est connectée en parallèle avec l'alimentation de la pompe de recirculation, de sorte que si la filtration est arrêtée, la pompe ne peut pas doser. Pour ne pas endommager la carte électronique, ne connectez pas l'Enable directement en parallèle avec l'alimentation de la pompe de recirculation, mais utilisez toujours un contacteur / relais.

Si votre pompe est équipée de l'entrée d'Enable (voir position B page 29 CONNECTIONS), vous pouvez choisir d'activer ou pas cette entrée. Si vous choisissez de le désactiver, la pompe ne vérifiera pas l'entrée d'activation pour doser le produit chimique.

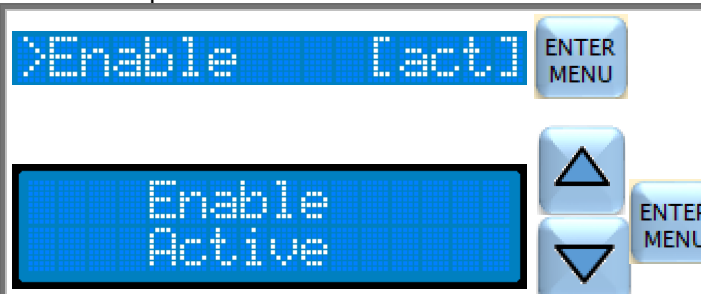
	<p>Dans le menu Set up, sélectionnez "Enable" avec le curseur et appuyez sur ENTER.</p> <p>Utilisez les touches ▼ ▲ pour activer ou désactiver l'entrée d'Enable, puis appuyez sur ENTER.</p> <p>Appuyez sur la touche ESC pendant 3 secondes pour quitter la programmation</p>
--	--

Si votre pompe n'a pas inclus l'option de Enable, il ne sera pas possible d'accéder à la modification et le message clignotant "DES" apparaîtra:

Enable DES

RUPTURE TUBE (OPTIONNEL)

Qu'est-ce que c'est?

C'est un capteur qui détecte si le tube péristaltique est cassé et laisse échapper le produit chimique. Lorsque l'alarme de rupture de tube se déclenche, elle arrête le dosage et s'affiche à l'écran.



Avant toute intervention débrancher la pompe du réseau électrique!



Au cours de l'opération, utilisez toujours les protections personnelles indiquées dans les avertissements d'utilisation du produit chimique dosé. Par exemple, utilisez des gants, un tablier, des lunettes, etc.

Le tube péristaltique doit donc être changé. La zone du capteur à l'intérieur du corps de pompe doit également être lavée et soigneusement séchée. Voir l'image explicative sur le côté. Une fois l'opération effectuée en toute sécurité, la pompe peut être redémarrée.

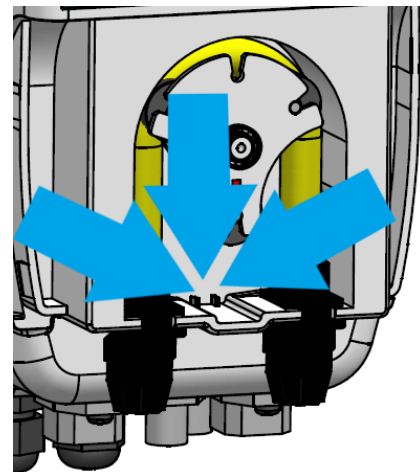

NB: AU REAMORGAGE, LA POMPE RAPPELLE QUE LE TUBE A ÉTÉ CASSÉ. POUR SORTIR DE L'ALARME, APPUYER SUR LE BOUTON ESC

Si votre pompe est équipée du capteur de rupture de tube péristaltique, vous pouvez choisir d'activer ou pas cette entrée.

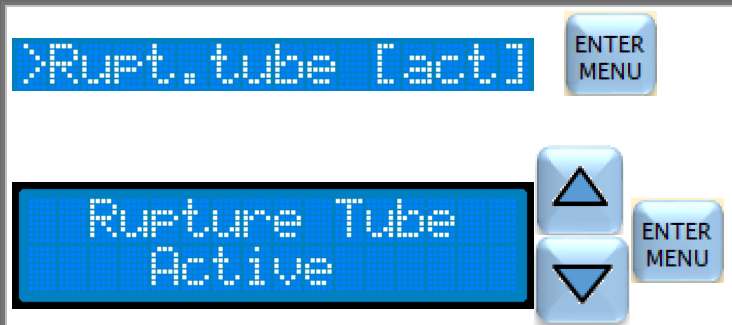
	<p>Dans le menu Set up, sélectionnez "Rupt.tube" avec le curseur et appuyez sur ENTER.</p> <p>Utilisez les touches ▼ ▲ pour activer ou désactiver l'entrée de Rupture Tube, puis appuyez sur ENTER.</p> <p>Appuyez sur la touche ESC pendant 3 secondes pour quitter la programmation.</p>
---	--

Si votre pompe n'a pas inclus l'option de Rupture Tube, il ne sera pas possible d'accéder à la modification et le message clignotant "DES" apparaîtra:

Rupt. tube DES

MENU ETALONNAGE (du debit)

La définition du débit de la pompe n'est pas nécessaire pour les dosages Manuelle, mA.

Dans ce modèle de pompe, la méthode empirique est utile pour la détermination précise du débit en conditions de travail.

La définition du débit (c'est-à-dire les litres / heure de produit dosé par la pompe) peut être réalisée en 2 manières. Un mode rapide (**Tableau Debit**) en lisant l'étiquette d'identification sur le côté de la pompe.

Un mode empirique et plus précis (**Etalon. Debit**) qui prend en compte les conditions de fonctionnement de la pompe (rodage du tube et du moteur par exemple).

TOUTES LES POMPES SONT PRECALIBREES EN USINE AVEC TABLEAU DE CAPACITE. Le débit n'est pas rétabli lors de la réinitialisation de la pompe (menu **Utilitaire**)

	<p>Appuyez sur le bouton ENTER / MENU pendant 3 secondes pour entrer en programmation.</p> <p>Utilisez la touche ▼ pour déplacer le curseur sur "Etalonnage". Appuyez sur ENTER pour entrer dans le sous-menu.</p> <p>Positionnez le curseur sur le type de calibration que vous voulez faire. Appuyez sur ENTER pour accéder au sous-menu et procéder au changement.</p> <p>Appuyez sur la touche ESC pendant 3 secondes pour quitter la programmation.</p>
--	---

MODE RAPIDE (TABLEAU DEBIT):

Lisez le modèle de pompe que vous avez sur l'étiquette appliquée sur la pompe (voir figure à côté) et écrivez-le dans le paramètre "Tableau Debit" comme suit:

S/N: XXXXXXXXXXXX

Type: XXXXXXXXXXXX

Code: XXXXXXXXXXXX

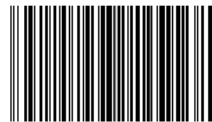

90-250Vac 50/60Hz 20W

6 l/h 1bar SANT



	<p>Dans le menu Etalonnage, sélectionnez "Tableau Debit" avec le curseur et appuyez sur ENTER.</p> <p>Lisez le débit indiqué sur l'étiquette de la pompe et utilisez les touches ▼▲ pour sélectionner la valeur, puis appuyez sur la touche ENTER à chaque fois pour confirmer le changement.</p> <p>Appuyez sur la touche ESC pendant 3 secondes pour quitter la programmation.</p>
--	--

MODE EMPIRIQUE

- Installez la pompe sur le système.
- Faire amorcer.

- À ce stade, insérer le tube d'aspiration dans un tube gradué rempli des ml d'eau à doser. Il est conseillé de définir une quantité telle que la pompe dose au moins 40 secondes / 1 minute.

Par exemple:

- 300 ml pour une pompe 20 litres / h; -200 ml pour une pompe de 12 litres / h; -100 ml pour une pompe de 6 litres / h; -50 ml pour une pompe de 3 litres / h; -30 ml pour une pompe de 2 litres / h.

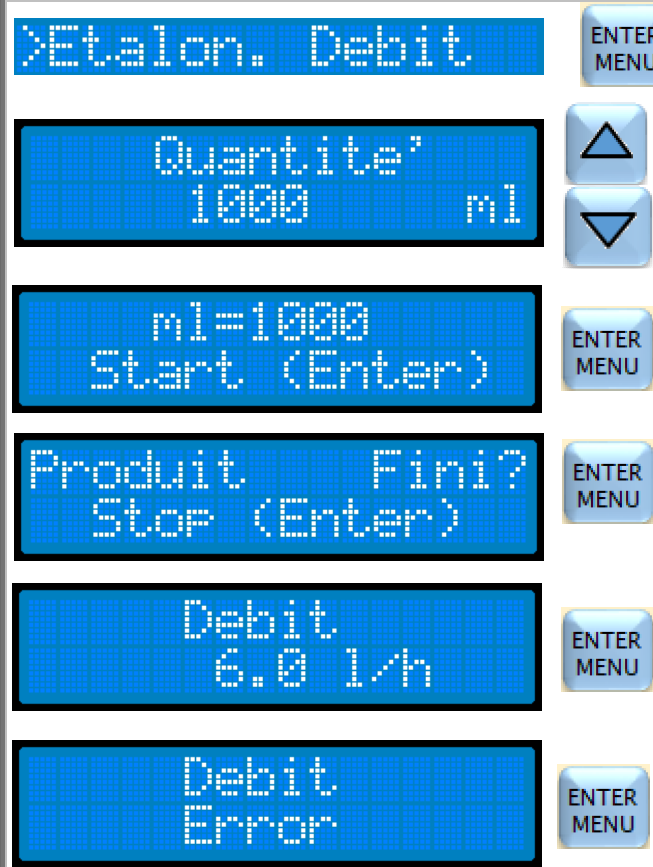

Pour des raisons de sécurité, la pompe doit être étalonnée avec de l'eau

	<p>Dans le menu Etalonnage sélectionnez "Etalon. Debit" et appuyez sur ENTER.</p> <p>Utilisez les touches ▼▲ pour sélectionner la quantité de produit à aspirer et appuyez sur la touche ENTER à chaque fois pour confirmer le changement.</p> <p>Appuyez sur ENTER pour commencer à doser la pompe.</p> <p>Dès que le conteneur est vide, appuyez sur ENTER pour arrêter le dosage de la pompe.</p> <p>La pompe calcule le débit et l'écrit, appuyez sur ENTER pour le confirmer.</p> <p>Si le message "Erreur de flux" s'affiche, répétez l'étalonnage en augmentant ou en diminuant la quantité de produit.</p> <p>Appuyez sur la touche ESC pendant 3 secondes pour quitter la programmation.</p>
---	--

MENU UTILITAIRE

Le menu Utilitaire vous permet de programmer le délai d'allumage et rétablir les paramètres d'usine de la programmation.

 <p>ENTER MENU 3sec</p> <p>>Utilitaire</p> <p>ENTER MENU</p> <p>>Ret.All. [00min] Reset</p>	<p>Appuyez sur le bouton ENTER / MENU pendant 3 secondes pour entrer en programmation.</p> <p>Utilisez la touche ▼ pour déplacer le curseur sur "Utilitaire". Appuyez sur ENTER pour entrer dans le sous-menu.</p> <p>Positionnez le curseur sur l'élément à modifier. Appuyez sur ENTER pour accéder au sous-menu et procéder au changement.</p> <p>Appuyez sur la touche ESC pendant 3 secondes pour quitter la programmation.</p>
---	---

RETARD D'ALLUMAGE

Qu'est-ce que c'est? Le **Retard d'allumage** est le temps en minutes (de 0 à 99 minutes) pendant lequel la pompe attend après son allumage pour doser le produit chimique. Pendant ce temps, le message "Retard Allumage" apparaît sur l'afficheur, qui alterne avec l'écriture du mode de fonctionnement et du débit. Pendant ce temps, la pompe ne peut pas doser mais il est possible d'accéder au menu pour modifier les paramètres et les calibrages.

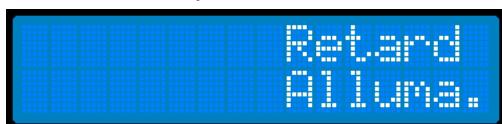

COMMENT PROGRAMMER LE RETARD D'ALLUMAGE:

 <p>>Ret.All. [00min]</p> <p>ENTER MENU</p> <p>Retard All 00 min</p> <p>ENTER MENU</p>	<p>Dans le menu Utilitaire, sélectionnez "Ret.All." avec le curseur et appuyez sur ENTER.</p> <p>Insérer avec les touches ▼ ▲ les minutes de retard souhaitées, puis appuyez sur ENTER.</p> <p>Attention: la modification sera active dès le prochain démarrage de la pompe!</p> <p>Appuyez sur la touche ESC pendant 3 secondes pour quitter la programmation</p>
--	---

RESTAURER LES PARAMÈTRES DE PROGRAMMATION D'USINE

Attention: la réinitialisation n'a aucune influence sur l'étalonnage du débit, de la date et de l'heure; langue, mot de passe.

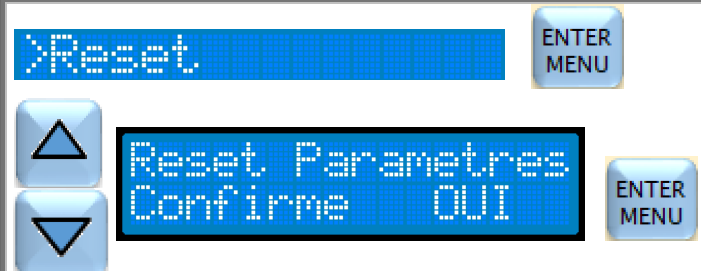
 <p>>Reset</p> <p>ENTER MENU</p> <p>Reset Parametres Confirme OUI</p> <p>ENTER MENU</p>	<p>Dans le menu Utilitaire, sélectionnez "Reset" avec le curseur et appuyez sur ENTER.</p> <p>Utilisez les touches ▼ ▲ jusqu'à voir pour afficher "Oui" sur Confirmer. Appuyez sur ENTER.</p> <p>La pompe rétablit automatiquement les réglages d'usine. Appuyez sur la touche ESC pendant 3 secondes pour quitter la programmation.</p>
--	--

MENU RELAIS (OPTIONNEL)

La sortie relais indique la présence d'une alarme. C'est un contact sans tension. La signalisation peut être effectuée avec la fermeture du contact ou avec l'ouverture (valeur par défaut est N.O). Voir le paragraphe suivant "Alarme". Dans le menu relais, vous décidez quelles alarmes peuvent être signalées par le relais.

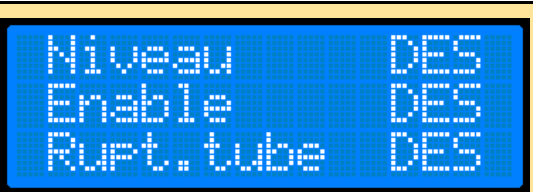
<p>NOTE IMPORTANT : Niveau, Enable et Rupture de tube sont optionnels. Si dans votre pompe ne sont pas présent, vous ne pourrez pas accéder aux sous-menus appropriés et dans le menu va apparaître :</p>	
--	--

	<p>Appuyez sur le bouton ENTER / MENU pendant 3 secondes pour entrer en programmation.</p> <p>Avec la touche ▼ déplacer le curseur sur le sous-menu « Relais ». Appuyez sur ENTER pour entrer dans le sous-menu.</p> <p>Positionnez le curseur sur l'élément à modifier. Appuyez sur ENTER pour accéder au sous-menu et procéder au changement.</p> <p>Appuyez sur la touche ESC pendant 3 secondes pour quitter la programmation.</p>
---	--

ALARME

	<p>Dans le menu Relais, sélectionnez "Alarme" avec le curseur et appuyez sur ENTER.</p> <p>Sélectionnez le mode de fonctionnement du relais souhaité avec les touches ▼ ▲ et appuyez sur ENTER. N.O = normalement ouvert (valeur par défaut) N.F = normalement fermé.</p> <p>Appuyez sur la touche ESC pendant 3 secondes pour quitter la programmation</p>
--	--

RETARD D' ALLUMAGE

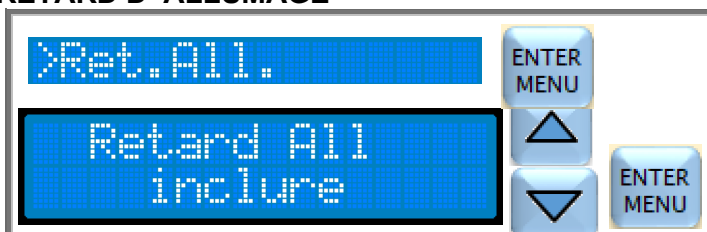
	<p>Dans le menu Relais, sélectionnez "Ret.All." avec le curseur et appuyez sur ENTER.</p> <p>Incluez ou excluez l'alarme avec les touches ▼ ▲ et appuyez sur ENTER.</p> <p>Appuyez sur la touche ESC pendant 3 secondes pour quitter la programmation.</p>
---	---

Pour inclure ou exclure les autres alarmes, suivez les mêmes étapes que le Retard d'Allumage.

MENU DOSAGE

Le menu **DOSAGE** vous permet de choisir:

le type de dosage de la pompe: **Manuelle, mA**.

NB: pour changer le type de dosage, confirmez avec la touche ENTER au moins un paramètre du nouveau dosage.

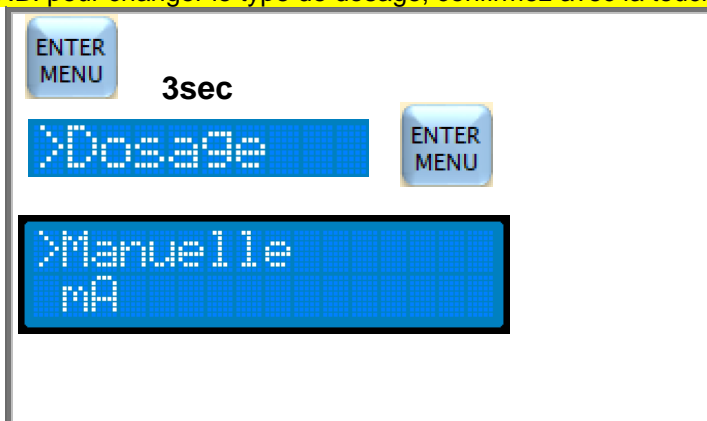
	<p>Appuyez sur le bouton ENTER / MENU pendant 3 secondes pour entrer en programmation.</p> <p>Utilisez la touche ▼ pour déplacer le curseur sur "Dosage". Appuyez sur ENTER pour entrer dans le sous-menu.</p> <p>Positionnez le curseur sur le type de dosage à choisir et appuyez sur ENTER pour accéder au sous-menu et procéder à la modification.</p> <p>Appuyez sur la touche ESC pendant 3 secondes pour quitter la programmation.</p>
--	--

-**Manuelle**, la pompe dose constamment au débit programmé. Il est possible d'activer un dosage cyclique avec temporisation programmable, temps ON et OFF

-**mA**, débit proportionnel au mA reçu, range de proportionnalité entièrement programmable

DOSAGE MANUELLE

Il ya 2 types de dosage manuel:

- 1) Lorsque le paramètre Cycle est désactivé (**Cycle [des]**), le dosage est constant au débit défini (%Débit).
- 2) Avec le paramètre Cycle actif (**Cycle [act]**), le dosage est constant au débit défini (%Débit) mais est également cyclique avec des temps programmables ON (Ton) et OFF (Toff). De plus, il est activé après un délai programmable (Td) lors de la mise en marche de la pompe ou lors de la réception du signal de validation. Cette dernière entrée est facultative et elle peut donc ne pas être présente. Voir le diagramme des connexions à page 29. NB: si l'activation facultative est présente, vous pouvez choisir de l'activer ou pas dans le menu SET UP; page 31.

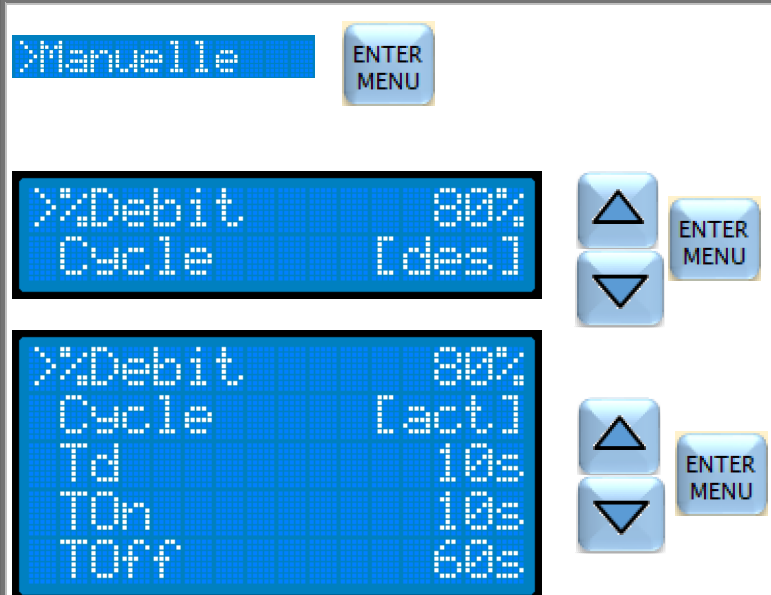

The screenshot shows two menu screens. The top screen shows '%Débit 80%' and 'Cycle [des]'. The bottom screen shows '%Débit 80%', 'Cycle [act]', 'Td 10s', 'Ton 10s', and 'Toff 60s'. Navigation arrows and 'ENTER MENU' buttons are shown between the screens.

Dans le menu **Dosage**, sélectionnez "**Manuelle.**" avec le curseur et appuyez sur **ENTER**.

Sélectionnez avec les touches ▲▼ le débit désiré et appuyez sur **ENTER**.

Dans la figure de gauche, vous pouvez voir les paramètres d'usine avec cycle désactivé et avec cycle actif.

Td: est le temps en secondes (de 0 à 9999 secondes) pendant lequel la pompe attend après sa mise sous tension ou après la réception du signal d'activation pour doser le produit chimique.

Ton: est le temps en secondes (de 0-9999sec) de dosage

Toff: c'est le temps en secondes (de 0 à 9999 secondes) de l'arrêt du dosage

Dosage Manuelle:

- A) Cycle désactivé
- B) Cycle actif

1. $t = t_1$: Instant de mise en marche de la pompe ou réception du signal de Enable
2. $t = t_2$: Instant de arrêt de la pompe ou une interruption du signal de Enable

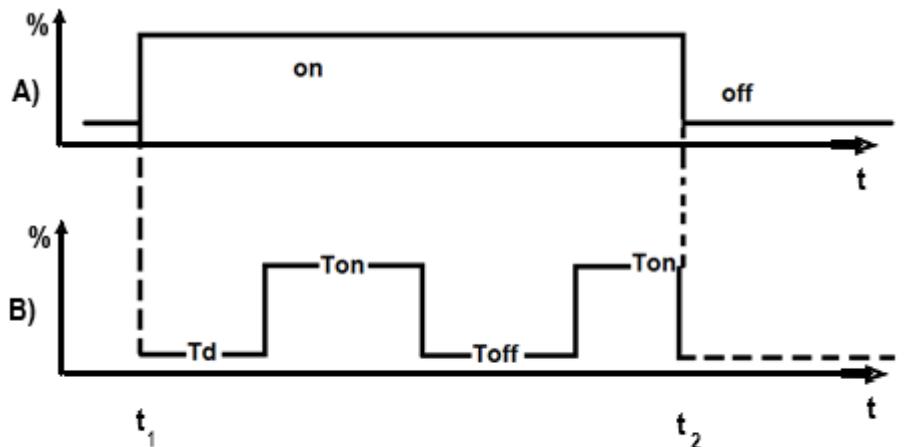

DOSAGE mA

Dosage proportionnel à la lecture de mA. L'intervalle de proportionnalité et le débit sont librement programmables.

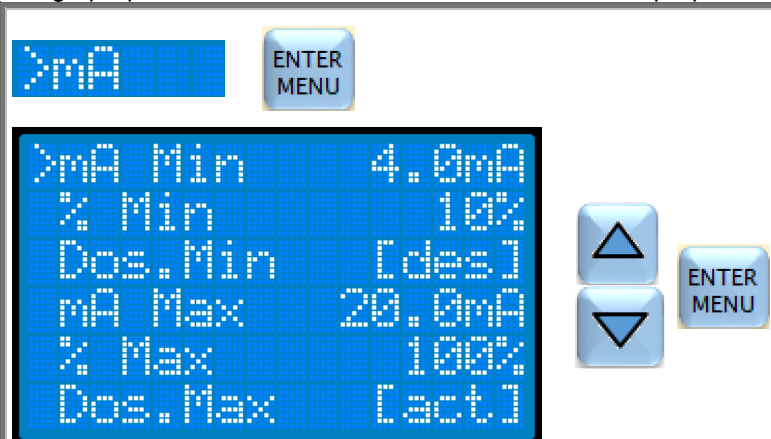

The screenshot shows a menu with parameters: '>mA Min 4.0mA', '% Min 10%', 'Dos. Min [des]', 'mA Max 20.0mA', '% Max 100%', and 'Dos. Max [act]'. Navigation arrows and 'ENTER MENU' buttons are shown.

Dans le menu **Dosage**, sélectionnez "**mA**" avec le curseur et appuyez sur **ENTER**.

Sur la figure ci-contre, les paramètres d'usine sont visibles.

Positionnez le curseur sur l'élément à modifier. Appuyez sur **ENTER** pour accéder au changement.

Utilisez les touches ▼ ▲ pour sélectionner la valeur souhaitée et appuyez sur la touche **ENTER** à chaque fois pour confirmer le changement.

Appuyez sur la touche **ESC** pendant 3 secondes pour quitter la programmation

PARAMETRES:

mA Min: valeur du courant minimale

% Min: débit de la pompe lorsque l'entrée dépasse le courant minimal

Dos.Min choisissez si en dessous du courant minimum la pompe doit doser **[act]** au débit **%Min** ou si elle ne doit pas doser **[des]**

mA Max: valeur du courant maximum

% Max: débit de la pompe lorsque le courant maximum est entré

Dos.Max: choisissez si au-dessus du courant maximum la pompe doit doser **[act]** au débit **%Max** ou si elle ne doit pas doser **[des]**.

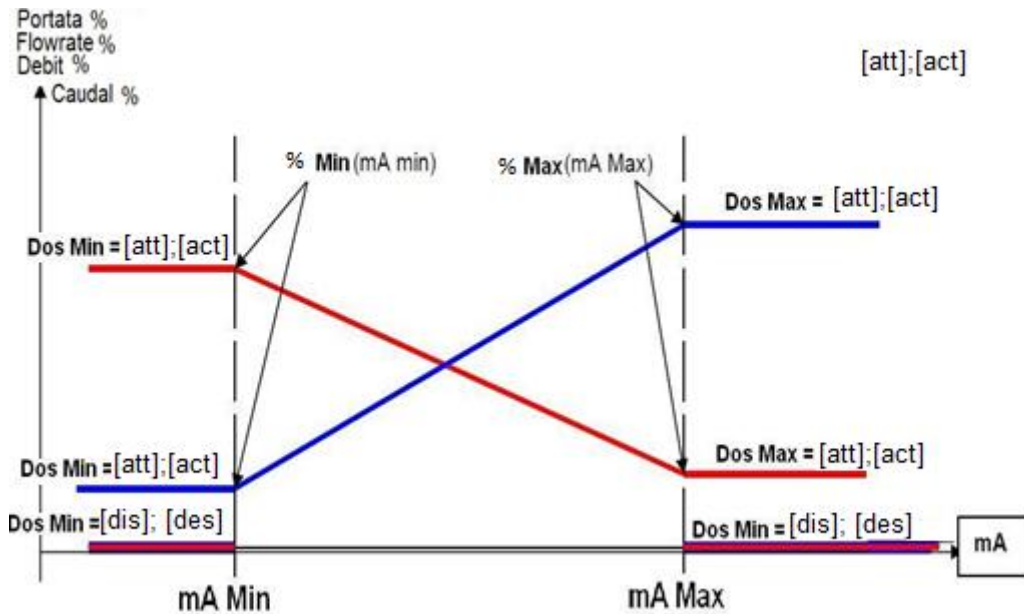

NB: AVEC LES PARAMETRES USINE, AVEC UN COURANT EN ENTREE DE 4,0mA, LA POMPE NE DOSE PAS, AVEC UN COURANT DE 20mA, LA POMPE DOSE A 100% DE DEBIT.

DESCRIPCIÓN DE LAS CARACTERÍSTICAS Y FUNCIONAMIENTO.

Las bombas dosificadoras "MP2-HT mA" son ideales para la dosificación en muy diversas aplicaciones. Pueden operar en modo Manual, mA y el caudal es ajustable del 10% al 100% del flujo máximo. Estas bombas regulan el caudal variando la velocidad de rotación del soporte del rollo. Como opción, pueden alojar un sensor de rotura de tubo peristáltico que, en caso de fugas de productos químicos, bloquea la dosificación y pueden tener una salida de relé, configurable para la repetición de una alarma (por ejemplo: alarma de nivel, rotura del tubo peristáltico, etc).

DESCRIPCION DEL PANEL FRONTAL

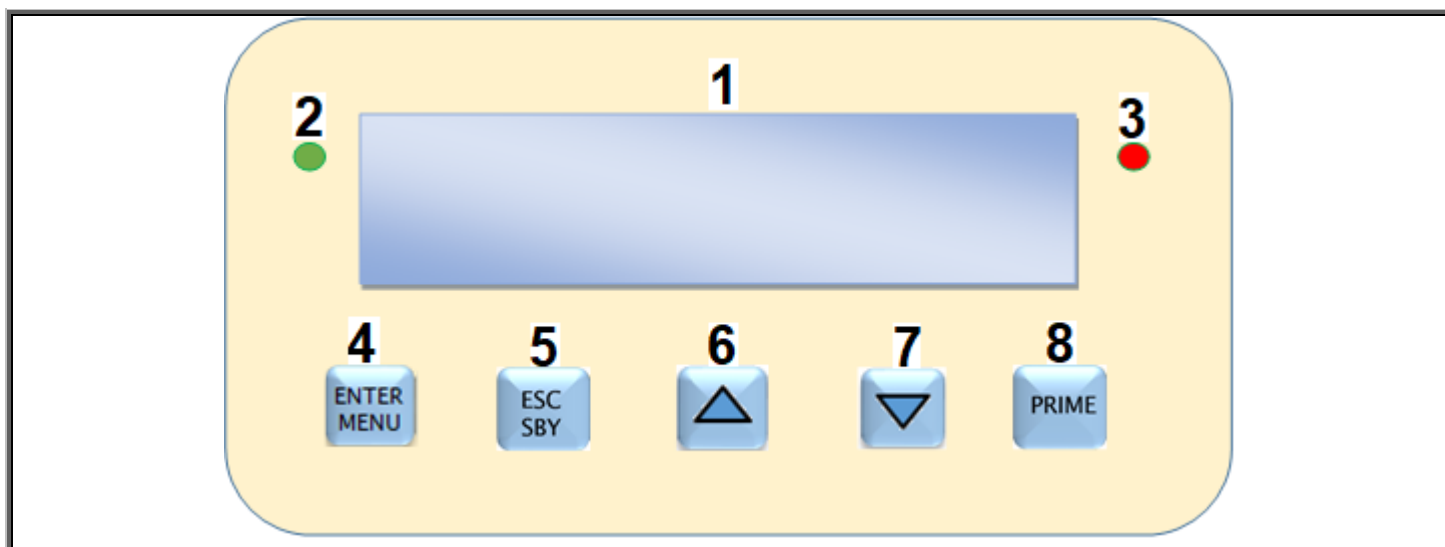

- | | |
|---|--|
| <p>1. Pantalla LCD 16 x 2 caracteres</p> <p>2. Led verde:
 ▪ fijo = BOMBA ENCENDIDA
 ▪ intermitente = BOMBA EN ALARMA</p> <p>3. Led rojo: indica las inyecciones del producto químico</p> <p>4. Tecla Enter/Menu:
 ▪ deja entrar en la programación
 ▪ Salva/Confirma las modificaciones</p> | <p>5. Tecla ESC/SBY:
 ▪ deja salir del menu
 ▪ pone la bomba en stand_by</p> <p>6 /7. Tecla ▼ ▲:
 ▪ Te permite navegar dentro del menú
 ▪ Cambiar el valor de los parámetros.</p> <p>8. Tecla Prime:
 ▪ Hace aspirar la bomba</p> |
|---|--|

FUNCIONES GENERALES:

- VISUALIZACIÓN DEL TIPO DE DOSIFICACIÓN
- VISUALIZACIÓN INSTANTÁNEA DEL **CAUDAL** EN %
- 2 POSIBLES **TIPOS DE DOSIFICACIÓN**: MANUAL, mA
- MENÚ EN **4 IDIOMAS**: ITALIANO, INGLÉS, FRANCÉS, ESPAÑOL
- POSIBILIDAD DE INSERCIÓN DE UNA **CONTRASEÑA** (password)
- **RETRASO DE IGNICIÓN**
- **TECLA DE CEBADO**
- **RELÉ DE ALARMA (CONTACTO LIMPIO)**: SALIDA PARA REPETIR ALARMAS
- **RESTAURACIÓN DE PARÁMETROS DE FÁBRICA**
- PARADA DE DOSIFICACIÓN (**STAND_BY**)
- CONTROL DE **NIVEL** PRODUCTO ACABADO
- SEÑAL DE ENTRADA '**ENABLE**'
- SENSOR DE **ROTURA DE TUBO**

CONEXIONES

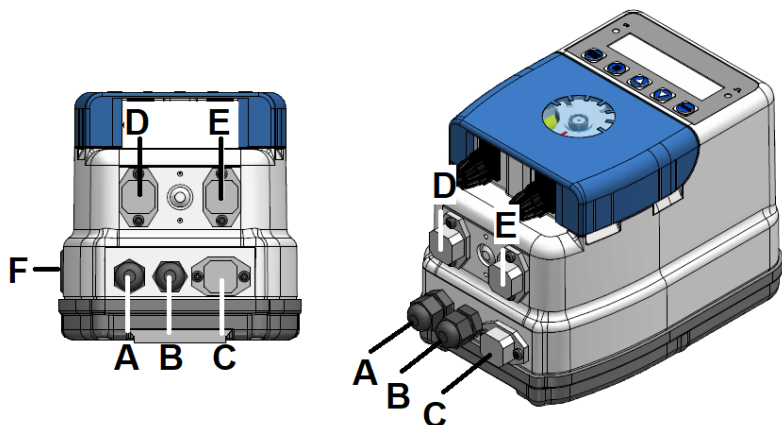

A- es el cable de alimentación, 90-250V-50-60 Hz

B - es la entrada de B de habilitación o consentimiento a dosificación (110Vac; 230Vac; 24V a pedido). **OPCIONAL**

C - es el conector de salida de relé para las alarmas. (Contactos 3 y 4). (5A 250Vca/30Vdc) **NORMALMENTE ABIERTO. OPCIONAL.**

D - es el conector de la sonda de nivel (contactos 3 y 4). **OPCIONAL.**

E - es el conector para la entrada mA (contactos 3 (+) y 4 (-))

F - es el interruptor de encendido / apagado (0/1). **OPCIONAL**

PARÁMETROS DE FÁBRICA

CONTRASEÑA = NO INSERTADA

Enable (opcional): activo

Rotura de tubo (opcional): activo

Retardo de ignición: 0 minutos

- DOSIFICACIÓN: **mA**
- mA Min: **4.0mA**
- % Min: **10%**
- Dos.Min: **des**
- mA Max: **20.0mA**
- % Max: **100%**
- Dos.Max: **act**

RESTAURACIÓN DE AJUSTES DE FÁBRICA



3sec



>Utilidades



>Reset



Reset Parametros
Confirma SI



Presione la tecla **ENTER / MENU** durante 3 segundos para entrar en la programación.

Use la tecla **▼** para mover el cursor a "Utilidades". Presione **ENTER** para entrar al submenú.

Presione **▼** para mover el cursor a "Reset". Presione **ENTER** para entrar.

Con la tecla **▼**, visualice "Sí" en Confirma. Presione **ENTER**.

Automáticamente la bomba restablece los ajustes de fábrica.

Presione la tecla **ESC** durante 3 segundos para salir de la programación.

PANTALLA EN DIFERENTES OPERACIONES

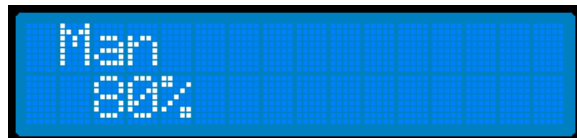

→ **Dosificación: Manual** con ciclo deshabilitado;

→ La bomba dosifica con caudal del 80%.

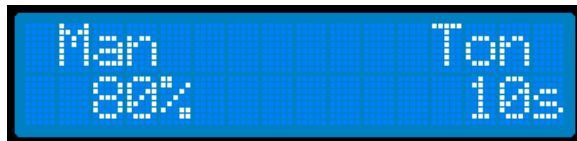

→ **Dosificación: Manual** con ciclo activo;

→ La bomba dosifica con un caudal del 80% para una Ton de 10 segundos.

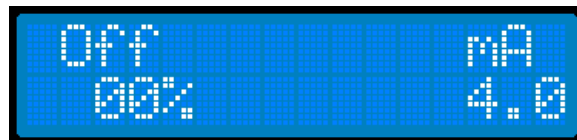

→ **Dosificación: mA;**

→ La bomba no dosa recibe una entrada de 4 mA.

STAND BY (STOP)

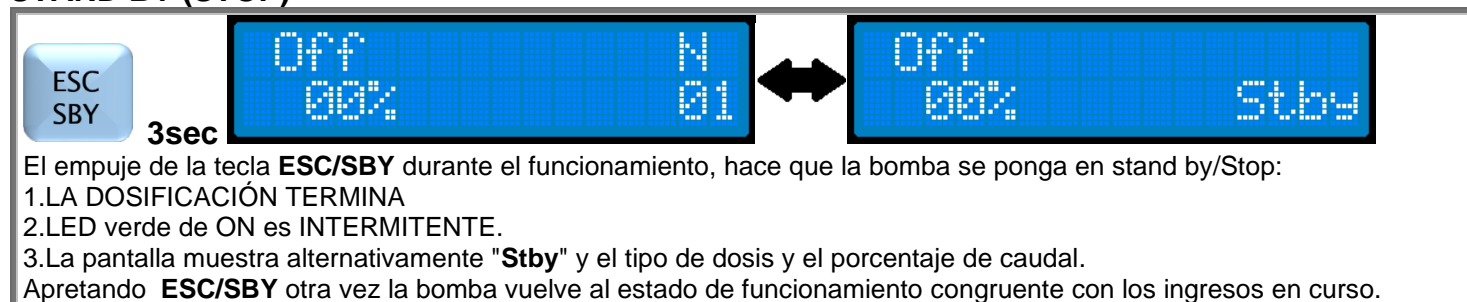

TECLA PRIME

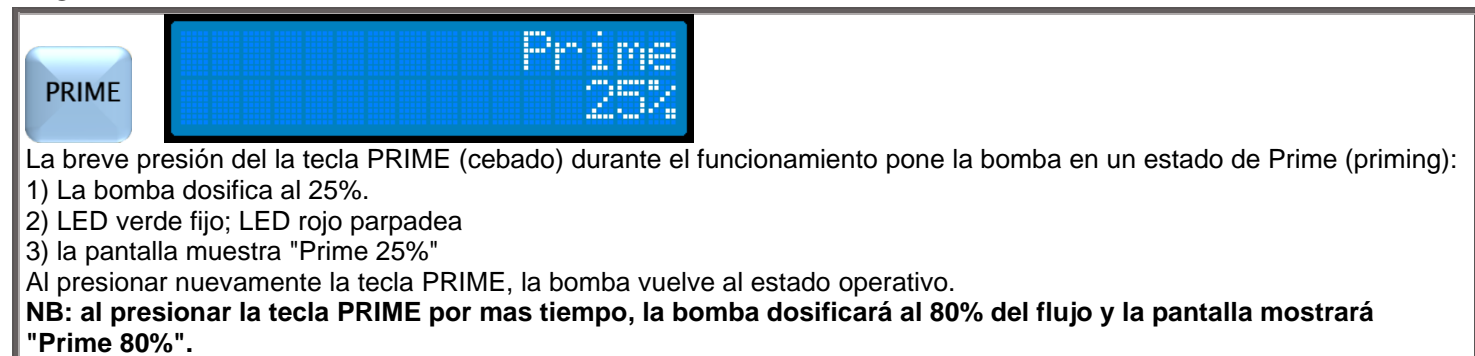

CONTROL DE NIVEL (OPCIONAL)



ESTRUCTURA DEL MENÚ PRINCIPAL

 <p>ENTER MENU 3sec</p>	<p>Pulse el botón ENTER / MENU durante 3 segundos para entrar en la programación.</p> <p>Con la tecla ▼ mover el cursor en el submenú de interés. Pulse ENTER para entrar en el submenú.</p> <p>Si desea abandonar la programación y volver a la medición, presione la tecla ESC durante 3 segundos.</p>
---	---

El menú de Set up se utiliza para elegir:

El idioma, el contraste de la pantalla, la contraseña (Password) de seguridad, se utiliza para activar o desactivar las entradas de Enable (habilitación de dosificación) y del sensor de rotura del tubo peristáltico.

El menú de Dosificación se utiliza para elegir:

El tipo de dosificación entre Manual, mA.

El menú de Calibración se utiliza para:

Calibrar el caudal o lo puede seleccionar de la etiqueta sobre la caja de la bomba

El menú Utilidades permite:

programar o no el Retraso de ignición y restaurar los parámetros de fábrica de la programación.

El menú Relè permite:

Elegir la operación del relé de alarma (N.A o N.C), incluir o excluir, desde la señalización del relé, los distintos tipos de alarma (Retardo de ignición, Standby, Nivel, Enable, Ruptura del tubo).

MENÚ SET UP

NOTA IMPORTANTE:

Enable y Rotura del tubo son opciones. Si no están en la bomba, no será posible acceder a los submenús y en el menú aparecerá:



 <p>ENTER MENU 3sec</p>	<p>Pulse la tecla ENTER/MENU durante 3 segundos para entrar en la programación</p> <p>Con el cursor selecciona Set up y pulsa ENTER.</p> <p>Posicione el cursor en el elemento a cambiar. Presione ENTER para ingresar al submenú y continuar con el cambio.</p> <p>Si desea abandonar la programación y volver a la medición, presione la tecla ESC durante 3 segundos</p>
---	--

IDIOMA

 <p>ENTER MENU</p>	<p>En el menú Set up, seleccione "Idioma" con el cursor y presione ENTER.</p> <p>Elija "Espanol" con las teclas ▼ ▲ y presione ENTER.</p> <p>Si desea abandonar la programación y volver a la medición, presione la tecla ESC durante 3 segundos.</p>
--	--

NB: el idioma no se restablece cuando se reinicia la bomba (menú Utilidades).

CONTRASEÑA

La contraseña (Password) protege la modificación de los menús **Dosificación**, **Utilidades** y **Relé**. No bloquea la **Calibración** y **Set up**.

Inicialmente la contraseña no está establecida y, por lo tanto es posible acceder a toda la programación.

Primera definición de la password:

	<p>En el menú Set up, seleccione "Password" con el cursor y presione ENTER.</p> <p>Esto da acceso a la redacción de la contraseña. Seleccione las cifras con las teclas ▼ ▲ y presione ENTER. Después del cuarto dígito, al presionar ENTER se define la contraseña. Toma nota con cuidado para no olvidarla. En caso de que la olvide, <u>llame al Servicio al Cliente</u>.</p> <p>Si desea abandonar la programación y volver a la medición, presione la tecla ESC durante 3 segundos.</p>
--	--

Cambio de contraseña:

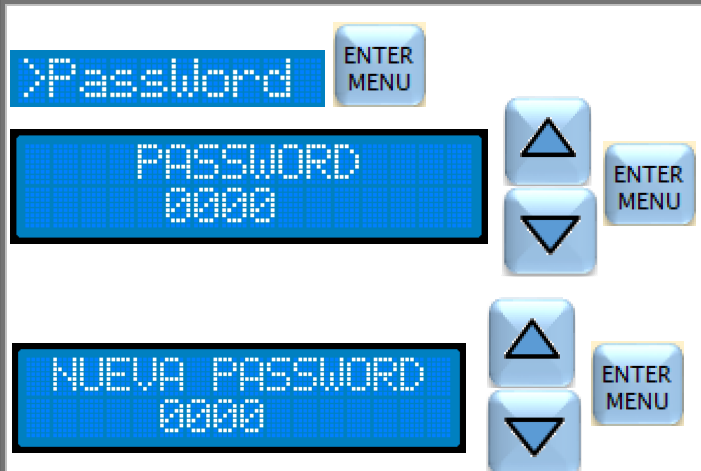
	<p>En el menú Set up, seleccione "Password" con el cursor y presione ENTER.</p> <p>Ingrese la contraseña vieja. Seleccione el dígito con las teclas ▼ ▲ y presione ENTER. Después el cuarto dígito, al presionar ENTER, puede cambiar la contraseña.</p> <p>Ingrese la nueva contraseña. Seleccione el dígito con las teclas ▼ ▲ y presione ENTER. Después de ingresar el cuarto dígito, al presionar ENTER se define la nueva contraseña. Toma nota con cuidado para no olvidarla. En caso de que la olvide, <u>llame al Servicio al Cliente</u>.</p> <p>Si desea abandonar la programación y volver a la medición, presione la tecla ESC durante 3 segundos.</p>
---	---

ENABLE (OPCIONAL)

La entrada de habilitación (ENABLE) es una entrada (230Vac-115Vac) que sirve para habilitar la bomba a la dosis. En las piscinas, esta entrada se conecta en paralelo con la fuente de alimentación de la bomba de recirculación, de modo que si se detiene la filtración, la bomba no puede dosificar. Para no dañar la tarjeta electrónica, no conecte la habilitación directamente en paralelo con la fuente de alimentación de la bomba de recirculación, siempre use un contactor / relé. En caso de que su bomba tenga habilitada (consulte la posición B página 40 CONEXIONES), puede optar por activar esta entrada o no. Si elige desactivarlo, la bomba no verificará la entrada de habilitación para dosificar el producto químico.

	<p>En el menú Set up, seleccione "Enable" con el cursor y presione ENTER.</p> <p>Use las teclas ▼ ▲ para seleccionar si desea habilitar (Activo) o deshabilitar (Desactivo) la entrada de habilitación de dosis y presione ENTER.</p> <p>Si desea abandonar la programación y volver a la medición, presione la tecla ESC durante 3 segundos</p>
--	--

En el caso de que su bomba no tiene esta opción, no será posible acceder a la modificación y aparecerá el mensaje parpadeante "DES":

Enable DES

RUPTURA TUBO (OPCIONAL)

¿Qué es?

Es un sensor que detecta si el tubo peristáltico está roto y deja salir las sustancias químicas.

Cuando se activa la alarma de ruptura del tubo, se detiene la dosificación y se señaliza en la pantalla.



Antes de cualquier intervención, desconecte la bomba de la red eléctrica !!



Durante la operación, utilice siempre las protecciones personales proporcionadas por las advertencias de uso del producto químico dosificado. Por ejemplo, use guantes, delantal, gafas, etc ...

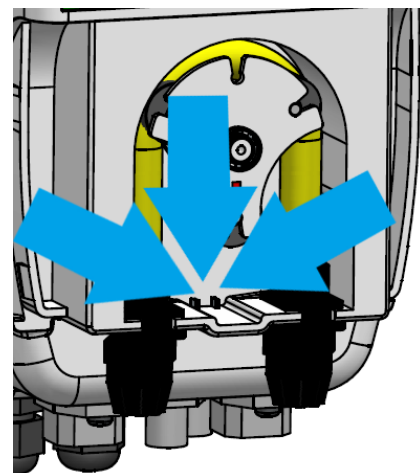

Por lo tanto, el tubo peristáltico debe ser cambiado. El área del sensor dentro de la carcasa de la bomba también debe enjuagarse y secarse cuidadosamente. Ver la imagen explicativa en el lateral. Una vez que la operación se ha realizado de manera segura, la bomba se puede reiniciar.

NB: AL REENCENDIR, LA BOMBA RECUERDA QUE EL TUBO FUE ROTO. PARA SALIR DE LA ALARMA, PRESIONE BREVEMENTE LA TECLA ESC.

En caso de que su bomba tenga el sensor de ruptura del tubo peristáltico, puede optar por activar esta entrada o no.

	<p>En el menú Set up, seleccione "Rupt.tubo" con el cursor y presione ENTER.</p> <p>Use las teclas ▼ ▲ para seleccionar si desea habilitar (Activo) o deshabilitar (Desactivo) la entrada de Ruptura Tubo y presione ENTER.</p> <p>Si desea abandonar la programación y volver a la medición, presione la tecla ESC durante 3 segundos</p>
--	--

En el caso de que su bomba no haya incluido la opción de Ruptura Tubo, no será posible acceder a la modificación y aparecerá el mensaje parpadeante "DES":



MENU DE CALIBRACIÓN (de caudal)

La definición del caudal de la bomba no es necesaria para las dosis de Manual, mA.

En este modelo de bomba, el modo empírico es útil para la determinación precisa del caudal en condiciones de trabajo.

La definición del caudal (es decir, los litros / hora de producto dosificado por la bomba) se puede efectuar en dos maneras. Un modo rápido (**Tabla Caudal**) leyendo la etiqueta de identificación en el lado de la bomba.

Un modo empírico y más precisa (**Calib. Caudal**) que tiene en cuenta las condiciones de trabajo de la bomba (por ejemplo, la rotura de tubos y motores).

TODAS LAS BOMBAS ESTÁN PRECALIBRADAS DE FÁBRICA CON TABLA CAUDAL. El caudal no se restablece cuando se reinicia la bomba (menú **Utilidades**).

	<p>Pulse la tecla ENTER/MENU durante 3 segundos para entrar en la programación</p> <p>Con el cursor seleccione Calibracion y pulse ENTER.</p> <p>Posicione el cursor en el tipo de calibración que desea hacer.</p> <p>Presione ENTER para ingresar al submenú y continuar con el cambio.</p> <p>Si desea abandonar la programación y volver a la medición, presione la tecla ESC durante 3 segundos</p>
--	---

MODO RÁPIDO (TABLA CAUDAL)

Lea el modelo de bomba que tiene en la etiqueta aplicada en la bomba (vea la figura al lado) y escríbalo en el parámetro "Tabla Caudal" de la siguiente manera:

S/N: XXXXXXXXXXXX

Type: XXXXXXXXXXXX

Code: XXXXXXXXXXXX



90-250Vac 50/60Hz 20W

6l/h 1bar SANT

6l/h



	<p>En el menú de Calibracion, seleccione con el cursor "Tabla Caudal" y presione ENTER.</p> <p>Lea la tasa de flujo en la etiqueta de la bomba y use las teclas ▼▲ para seleccionar el valor deseado y presione la tecla ENTER cada vez para confirmar el cambio.</p> <p>Si desea abandonar la programación y volver a la medición, presione la tecla ESC durante 3 segundos.</p>
--	---

MODO EMPÍRICO

- Instalar la bomba en el sistema.

- Dejarla aspirar

- Insertar el tubo de succión en una probeta

graduada llena de ml de agua a dosificar. Es aconsejable definir una cantidad tal que la bomba dosifique durante al menos 40 segundos / 1 minuto.

Por ejemplo:

-300ml para una bomba de 20 litros / h; -200 ml para una bomba de 12 litros / h; -100 ml para una bomba de 6 litros / h; -50 ml para una bomba de 3 litros / h; -30ml para una bomba de 2 litros / h.



Por razones de seguridad, la bomba debe calibrarse con agua.

	<p>En el menú de Calibracion, seleccione con el cursor "Calib. Caudal" y presione ENTER.</p> <p>Use las teclas ▼▲ para seleccionar la cantidad de producto a ser aspirado y presione la tecla ENTER cada vez para confirmar el cambio.</p> <p>Presione ENTER para comenzar a dosificar la bomba.</p> <p>Tan pronto como el contenedor esté vacío, presione ENTER para detener la dosificación de la bomba.</p> <p>La bomba calcula el caudal y lo escribe, presione ENTER para confirmar.</p> <p>Si aparece el mensaje "Caudal Error", repita la calibración aumentando o disminuyendo la cantidad de producto.</p> <p>Si desea abandonar la programación y volver a la medición, presione la tecla ESC durante 3 segundos.</p>
--	---

MENÚ UTILIDADES

El menú Utilidades le permite programar el Retraso de ignición y restaurar los parámetros de fábrica de la programación.

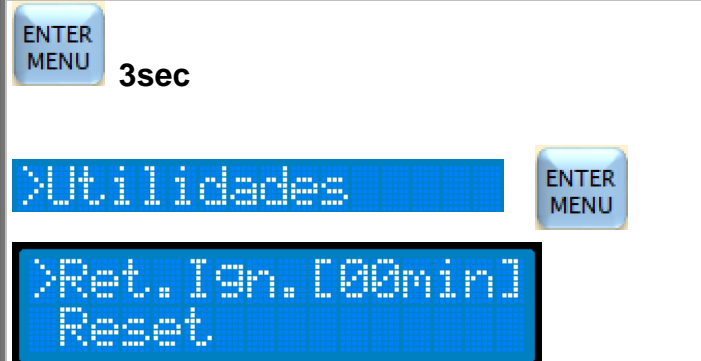
	<p>Pulse la tecla ENTER/MENU durante 3 segundos para entrar en la programación</p> <p>Con el cursor seleccione Utilidades y pulsa ENTER.</p> <p>Posicione el cursor en el elemento a cambiar. Presione ENTER para ingresar al submenú y continuar con el cambio.</p> <p>Si desea abandonar la programación y volver a la medición, presione la tecla ESC durante 3 segundos</p>
--	--

RETARDO DE IGNICION

¿QUÉ ES? El Retraso de Ignición es el tiempo en minutos (de 0 a 99 minutos) que la bomba espera después del encendido para dosificar el producto químico. Durante este tiempo, el mensaje "Retard Ignic." se mostrará en la pantalla alternando con la escritura del modo de dosificación y el caudal. Durante este tiempo, la bomba no dosifica, pero se puede acceder al menú para cambiar los parámetros y las calibraciones.

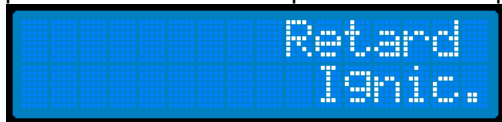

COMO PROGRAMAR EL RETRASO DE LA IGNICION:

	<p>En el menú Utilidades, seleccione "Ret.Ign." con el cursor y presione ENTER.</p> <p>Use las teclas ▼ ▲ para ingresar los minutos de retraso deseados y presione ENTER.</p> <p><u>Atención: la modificación estará activa desde el próximo arranque de la bomba!</u></p> <p>Si desea abandonar la programación y volver a la medición, presione la tecla ESC durante 3 segundos</p>
---	---

RESTAURACIÓN DE PARÁMETROS DE PROGRAMACIÓN

Atención: Restaurar no afecta a la calibración de la caudal; Fecha y hora; Idioma; Contraseña.

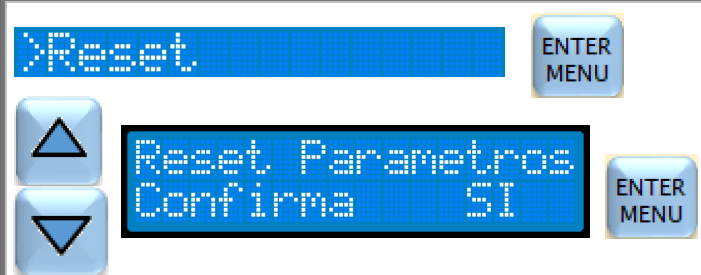
	<p>En el menú Utilidades, seleccione "Reset" con el cursor y presione ENTER.</p> <p>Con las teclas ▼ ▲, visualice "Sí" en Confirma. Presione ENTER.</p> <p>Automáticamente la bomba restaura los ajustes de fábrica. Presione la tecla ESC durante 3 segundos para salir de la programación.</p>
--	--

MENÚ RELÉ (OPCIONAL)

La salida de relé señala la presencia de una alarma. Es un contacto libre de tensión. La señalización puede ocurrir con el cierre del contacto o con la apertura (el valor predeterminado es N.A). Vea el siguiente párrafo "Alarma". En el menú del relé, puede decidir qué alarmas pueden ser señalizados por el relé.

NOTA IMPORTANTE:

El nivel, habilitación y rotura de tubo son opcionales. Si no están presentes en su bomba, no podrá acceder a los submenús relevantes y en el menú verá:

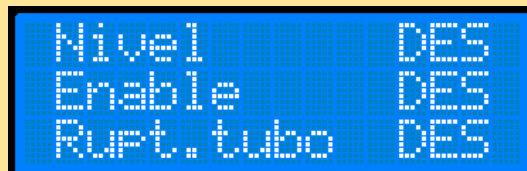

	<p>Pulse la tecla ENTER/MENU durante 3 segundos para entrar en la programación</p> <p>Con el cursor seleccione Relé y pulse ENTER.</p> <p>Posicione el cursor en el elemento a cambiar. Presione ENTER para ingresar al submenú y continuar con el cambio.</p> <p>Si desea abandonar la programación y volver a la medición, presione la tecla ESC durante 3 segundos</p>
---	--

ALARMA

	<p>En el menú Relé, seleccione "Alarma" con el cursor y presione ENTER.</p> <p>Use las teclas ▼ ▲ para seleccionar el modo de operación del relé deseado y presione ENTER. N.A = Normalmente Abierto (valor predeterminado) N.C = Normalmente Cerrado</p> <p>Si desea abandonar la programación y volver a la medición, presione la tecla ESC durante 3 segundos.</p>
---	---

RETARDO DE IGNICIÓN

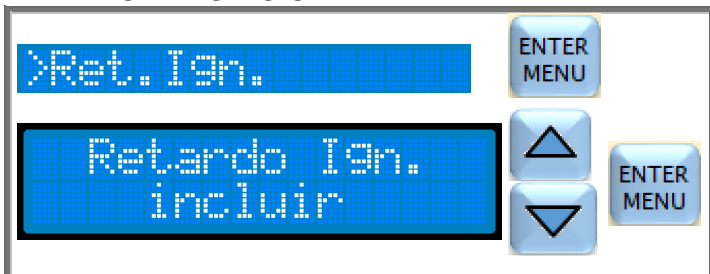
	<p>En el menú Relé, seleccione "Ret." con el cursor y presione ENTER.</p> <p>Incluir o excluir la alarma con las teclas ▼ ▲ y pulse ENTER.</p> <p>Si desea abandonar la programación y volver a la medición, presione la tecla ESC durante 3 segundos.</p>
--	--

Para INCLUIR o EXCLUIR las otras alarmas, siga los mismos pasos que el Retardo de Ignición.

MENÚ DE DOSIFICACIÓN

El menú de **DOSIFICACIÓN** le permite elegir:
el tipo de dosificación de la bomba: **MANUAL**, **mA**.

NB: para cambiar el tipo de dosis, confirme con la tecla **ENTER** al menos un parámetro de la nueva dosis.

	<p>Pulse la tecla ENTER/MENU durante 3 segundos para entrar en la programación</p> <p>Con el cursor seleccione Dosificación y pulse ENTER.</p> <p>Coloque el cursor en el tipo de dosis a elegir y presione ENTER para ingresar al submenú y continuar con la modificación.</p> <p>Si desea abandonar la programación y volver a la medición, presione la tecla ESC durante 3 segundos.</p>
--	--

-**Manual**, la bomba dosifica constantemente al caudal programado. Es posible activar una dosis cíclica con retardo programable, tiempos de ENCENDIDO y APAGADO

-**mA**, caudal proporcional al mA recibido, rango de proporcionalidad totalmente programable

DOSIFICACION MANUAL

Hay 2 tipos de dosis Manuales:

- 1) Con el parámetro Ciclo desactivado (**Ciclo [des]**), la dosis es constante a la velocidad de caudal definida (% Caudal)
- 2) Con el parámetro Ciclo activo (**Ciclo [act]**), la dosis es constante a la tasa de caudal definida (% caudal) pero también es cíclica con tiempos programables de ENCENDIDO (**Ton**) y APAGADO (**Toff**). Además, se activa después de un retardo programable (**Td**) cuando la bomba está encendida o cuando se recibe la señal de habilitación. Esta última entrada es opcional y por lo tanto puede no estar presente. Consulte el diagrama de conexiones en la página 40. Nota: si está presente la habilitación opcional, puede elegir si desea habilitarla o no en el menú SET UP; página 42.

>Manual ENTER MENU

>% Caudal 80%
Ciclo [des] ENTER MENU

▲ ▼

>% Caudal 80%
Ciclo [act]
Td 10s
Ton 10s
Toff 60s ENTER MENU

▲ ▼

En el menú de **Dosificación**, seleccione con el cursor "**Manual**" y presione **ENTER**.

Use las teclas ▼▲ para seleccionar el parámetro que desea cambiar y presione **ENTER**.
En la figura de la izquierda puede ver los parámetros de fábrica con el ciclo desactivado y con el ciclo activo.

Td: es el tiempo en segundos (de 0-9999seg) que la bomba espera después de su encendido o después de recibir la señal de habilitación para dosificar el químico.

Ton: es el tiempo en segundos (de 0-9999seg) de dosificación

Toff: este es el tiempo en segundos (de 0-9999sec) de la parada de dosificación

Dosificación manual:

- A) Ciclo desactivado
- B) Ciclo activo

1. $t = t_1$: Instante de encender la bomba o recibir la señal de habilitación
2. $t = t_2$: Instante para apagar la bomba o interrumpir la señal de habilitación

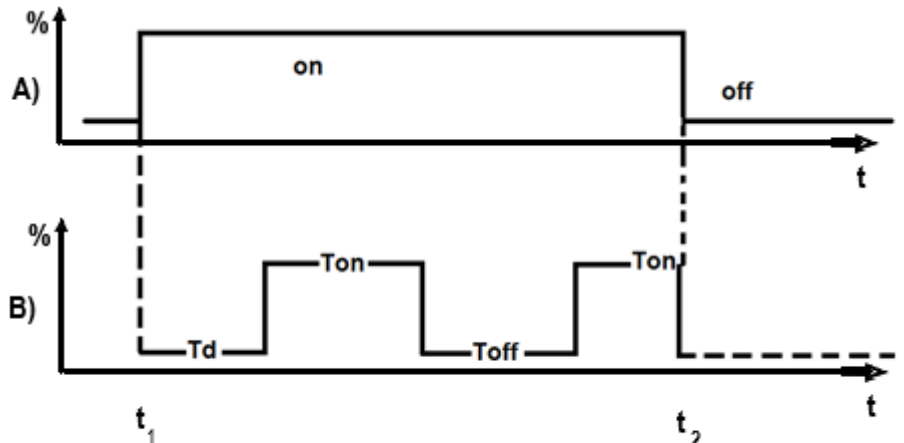

DOSIFICACION mA

Dosificación proporcional a la lectura de mA. El rango de proporcionalidad y el rango son libremente programables.

>mA ENTER MENU

>mA Min 4.0mA
% Min 10%
Dos.Min [des]
mA Max 20.0mA
% Max 100%
Dos.Max [act] ENTER MENU

▲ ▼

En el menú de **Dosificación**, seleccione con el cursor "**Proporcional**" y presione **ENTER**.
En la figura al lado se muestran los parámetros de fábrica.

Use las teclas ▼▲ para seleccionar el parámetro a modificar y presione **ENTER** para ingresar la modificación.

Use las teclas ▼▲ para seleccionar el valor deseado y presione la tecla **ENTER** cada vez para confirmar el cambio.

Si desea abandonar la programación y volver a la medición, presione la tecla **ESC** durante 3 segundos.

PARAMETROS:

mA Min: valor de la corriente mínima

% Min: caudal de la bomba cuando la entrada excede la corriente mínima.

Dos.Min: elija si, por debajo de la corriente mínima, la bomba debe dosificar **[act]** al **% Min** de caudal o no debe dosificar **[des]**.

mA Max: valor de la corriente máxima

% Max: caudal de la bomba cuando se ingresa la corriente máxima

Dos.Max: elija si por encima de la corriente máxima, la bomba debe dosificar **[act]** al **% Max** de caudal o no debe dosificar **[des]**.

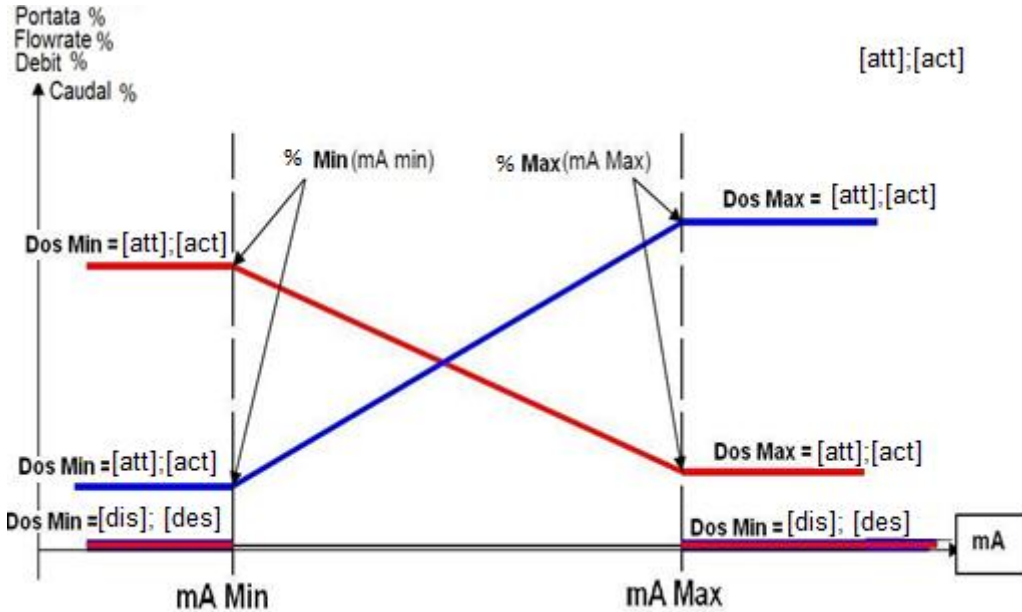

NB: CON LOS PARÁMETROS DE FÁBRICA, CON UNA CORRIENTE DE ENTRADA DE 4,0 mA LA BOMBA NO DOSIFICA, CON UNA CORRIENTE DE ENTRADA DE 20 mA LA BOMBA DOSIFICA AL 100% DE LA CAUDAL.

MICRODOS SRL
Sede legale: Via maestri del lavoro, 5 - 02010 Vazia (Ri)
tel. +39 0746 229064 fax. +39 0746 221224 Web site: www.microdos.it E-mail: info@microdos.it