

VERDERAIR **DOUBLE DIAPHRAGM PUMPS**

VERDERAIR[®]

VERDERAIR **EODD**

Electric driven double diaphragm pumps



VERDER
passion for pumps

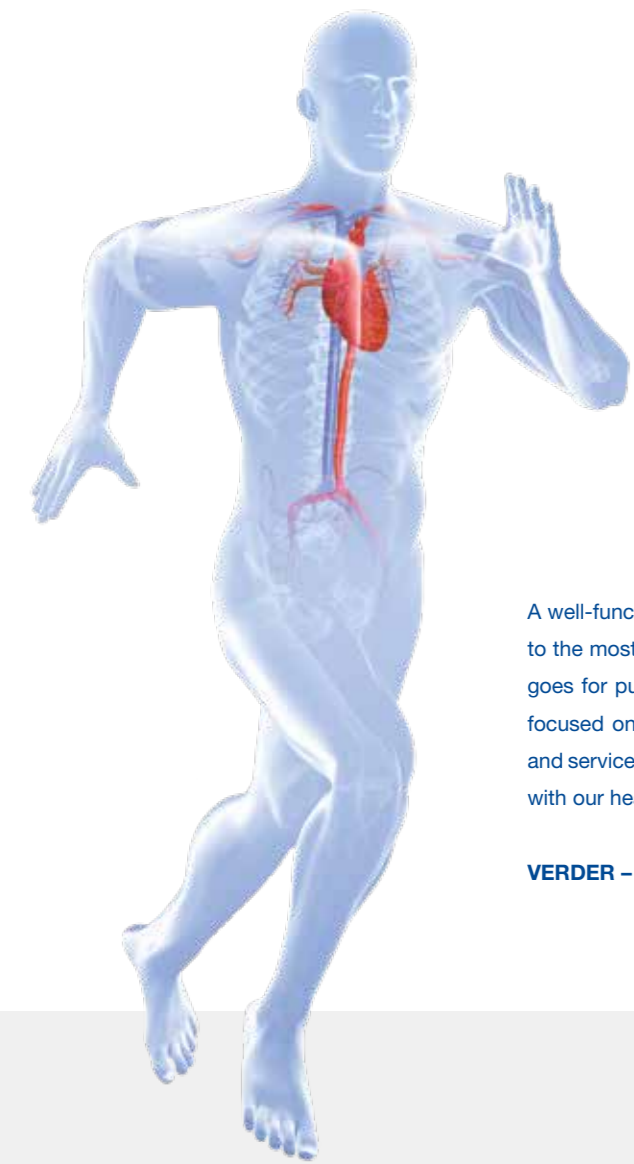

A well-functioning pump helps you succeed. That applies certainly to the most important pump in life, the human heart, but the same goes for pumps in business. At Verder, all energy and attention is focused on improving the quality and performance of our pumps and service. We do so with energy, dedication and most importantly, with our heart.

VERDER – PASSION FOR PUMPS

EASY, SAFE & EFFICIENT

Double diaphragm pumps are characterized by their easy operation and maintenance. They are seal-less, leak-free and ideally suited for chemicals, solvents and oily liquids.

EASY: WORKS LIKE A CONVENTIONAL AIR OPERATED DIAPHRAGM PUMP. LOW MAINTENANCE, EASY OPERATION AND A SAFE DISPLACEMENT.

SAFE: THANKS TO THE INNOVATIVE AIR CUSHION CONSTRUCTION, THE MOTOR CAN CONTINUE TO RUN, ALSO AGAINST CLOSED PRESSURE LINE.

EFFICIENT: SAVES UP TO 80% ON ENERGY COSTS!

The Verderair VA-E electric driven double diaphragm pumps are the only EODD pumps in the market that can run against a closed discharge valve without the need for additional pressure relief valves. The pump can also run at low pulsation operation without the need for a pulsation dampener.



VERDERAIR®



EASY
ALL ADVANTAGES OF AN AODD PUMP

The electric double diaphragm pump Verderair VA-E is characterized by its innovative air cushion design. Thanks to this, it can - like a traditional air operated diaphragm pump - also run against closed valves or clogged lines without being damaged. No additional security measures are needed.

The motor generates an oscillating movement, which is transformed into a diaphragm movement with support of the air cushion. The air cushion pressurizes the diaphragms alternately, similar to a traditional AODD.

Control options are available for PLC and SCADA, also possible for potentially explosive environments (ATEX).

- **Seal-less design: leak-free pumping**
- **Can run against closed discharge line**
- **Dry running and self-priming up to approx. 8 mwc**
- **PLC or SCADA control option**
- **ATEX versions available**





GENTLE OPERATION

Between the diaphragms there is an air cushion. The diaphragms are floatingly connected to the center piston. The center piston is reciprocating left to right in the housing driven by the gear box.

By moving to the left the piston will pull the right diaphragm also to the left, performing a suction stroke. With the same movement this diaphragm is creating extra pressure in the air cushion. The air cushion presses on the left diaphragm creating a delivery stroke. At the end of the stroke the center piston will change movement from right to left and the function of the diaphragms reciprocate from discharge to suction and vice versa.

Is the back pressure too high - for example due to a closed valve - then the medium will remain in the pump chambers until the pressure decreases again. Since the center piston and the diaphragms are not firmly connected, the motor can continue running without moving the diaphragms.

The air cushion is initially filled once (needs only to be maintained like keep under pressure as a tire). Therefore it is wise to have compressed air available.

- The air cushion is filled only once (0.6 l), hardly uses up air, remains under pressure like a tire
- The diaphragms are activated alternately
- The pressure side pushes the medium into the pipeline, while the other side primes the medium
- The electric double diaphragm pump consumes no more compressed air

VERDERAIR®



PRODUCT VIDEOS AT
WWW.VERDERLIQUIDS.COM

EASY TO OPERATE JUST LIKE AN AIR OPERATED DIAPHRAGM PUMP

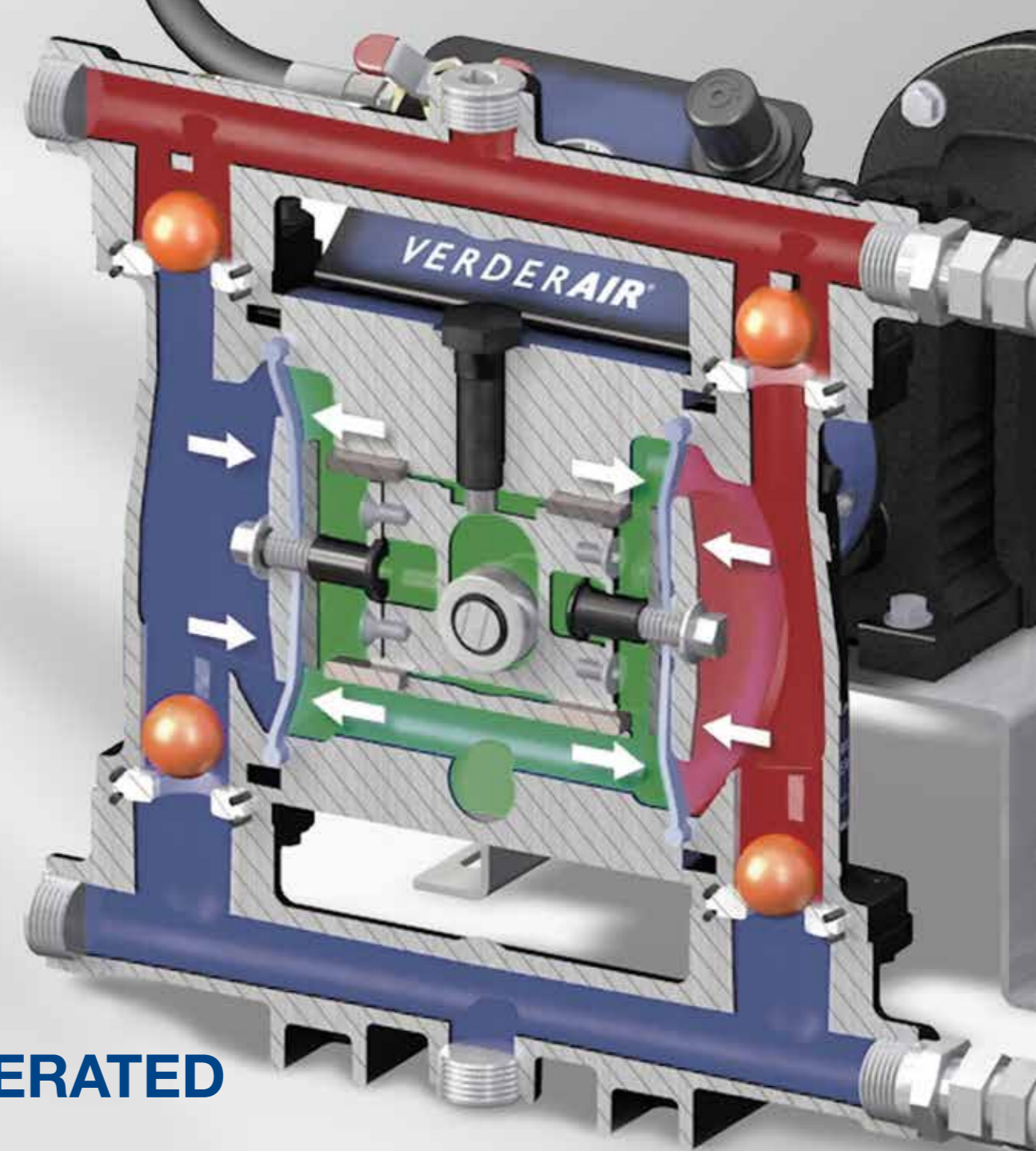

“The EODD can be connected to e.g. spray lances and functions as easy as an AODD pump”



THE EASE OF AIR CUSHION

Easy to batch

With the air cushion system accurate and repeatable dispensed volumes can be achieved. E.g. the EODD can be connected to spray lances directly and functions as ideal feeding pump by keeping the line under a constant pressure.

Easy to use

Use the pump as easily as an AODD pump. It is easy to start up, it is safely self-priming and the pump can run against closed discharge lines. No need to give special training to your personnel.

Easy to boost

An EODD pump easily holds your line to pressure; you don't need to switch off the pump. No additional security accessories necessary.

Easy low pulsation mode

The low pulsation mode can easily be configured: the pressure of the air cushion must be very close to the back pressure but must exceed the discharge pressure. By adjusting the pressure of the air-cushion, suction and discharge strokes are overlapping resulting in an almost continuous (low pulse) flow.

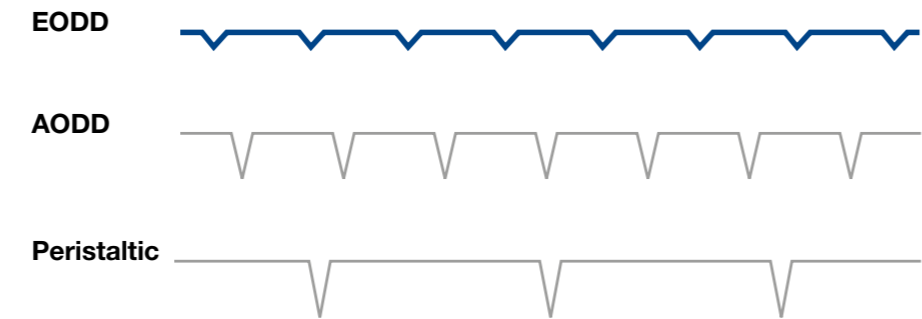

EASY PUMPING

Since the pumps are self-priming it is easy to start up your process. The Verderair EODD pumps are available as industrial and hygienic version and in 2 commonly used sizes, with 25 and 50 mm connections. Stainless Steel, PP and Aluminium versions available. No risk of contamination due to the absence of hydraulic backing.

Motors

Available in AC and DC motors with smart control; easy to integrate and control from your PC/PLC. There are several drive options: gearboxes with an AC drive, Gearbox with an ATEX drive or with an integrated compressor.

- Self-priming and low shear
- Dry running: eliminates downtimes and repair costs
- Increased diaphragm life
- Low pulsation mode, no dampeners needed
- PLC or SCADA control option
- Solids up to 6.3 mm



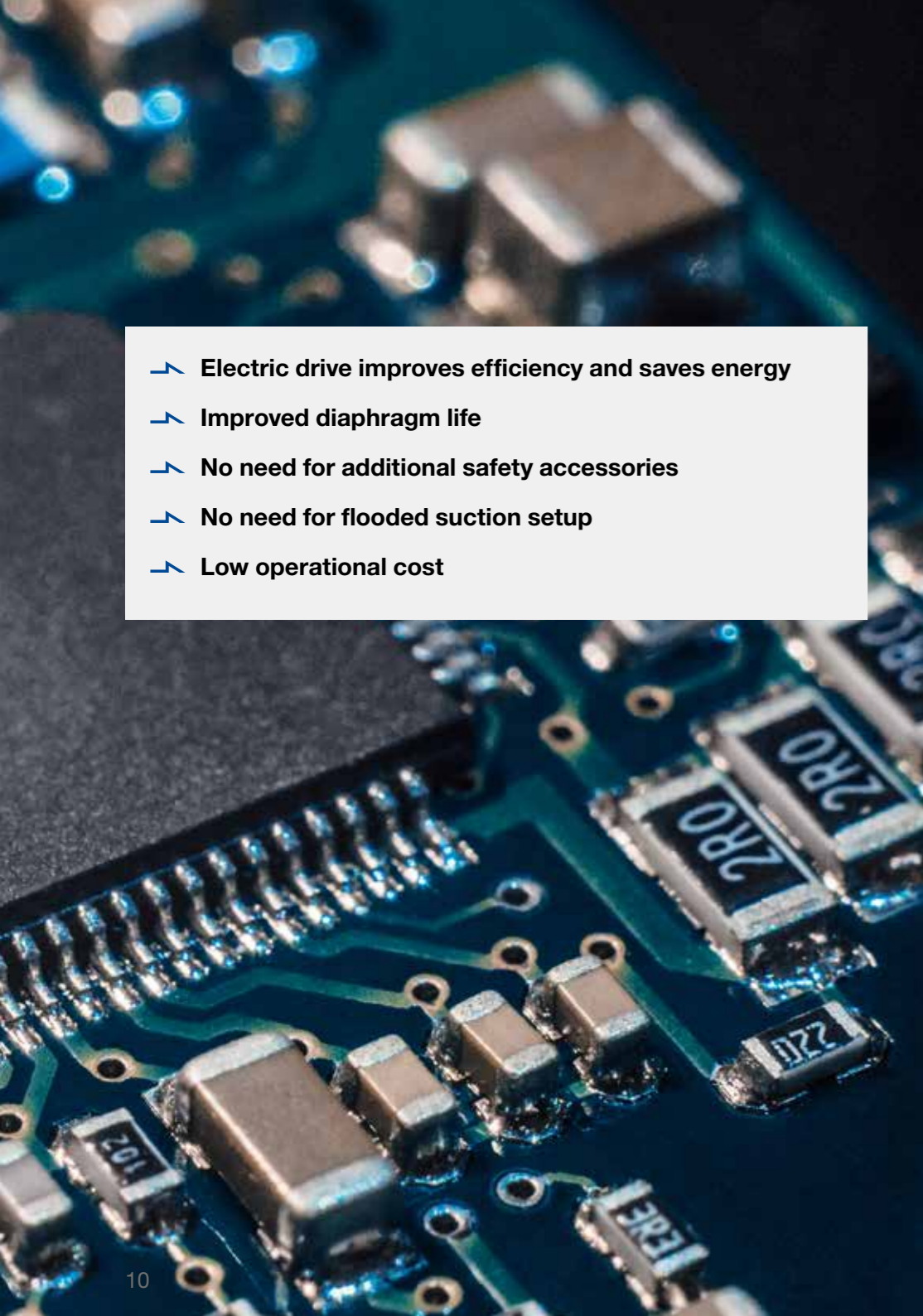

- **Electric drive improves efficiency and saves energy**
- **Improved diaphragm life**
- **No need for additional safety accessories**
- **No need for flooded suction setup**
- **Low operational cost**

EODD JUST LIKE AN AODD

Seal-less, leakproof design prevents fluid waste and spillage

Diaphragm pumps are leak-free since they have no plungers or piston rods, which pass through the pressure boundary. Expensive or dangerous fluids are pumped safely without any loss.

Heavy duty diaphragms

Overmolded diaphragms improve wear resistance and double diaphragm life. Especially with more aggressive fluids the life time can be extended up to 5 times.

Can run dry without pump damage

Diaphragm pumps are designed to run dry without damage. No packing glands are needed and there are no close-fitting, sliding, or rotating parts to maintain.

Self-priming up to 8.6 mwc

Double diaphragm pumps can easily prime up to 8.6 mwc. There is no need for a flooded section set-up. Your piping work can remain as it is. They are self-priming from a dry start.

Shear sensitive pumping

Double diaphragm pumps handle shear-sensitive fluids gentle, and can pump solids. These properties are especially important when pumping paint, polymers, food and similar vulnerable fluids.

EASY TO OPERATE AND MAINTAIN

The electric driven double diaphragm pump can be easily operated and maintained like a regular Verderair pump. The pump fluid side comprises the same parts as our proven Verderair VA.

Easy installation

Since Verderair EODD liquid side is equal to Verderair VA liquid side, the installation is as easy as installing a regular AODD pump. Additionally all connections are identical - the pumps are easily exchangeable.

Simple maintenance

An EODD pump is maintained in the same simple way as an AODD pump. Quick and easy.



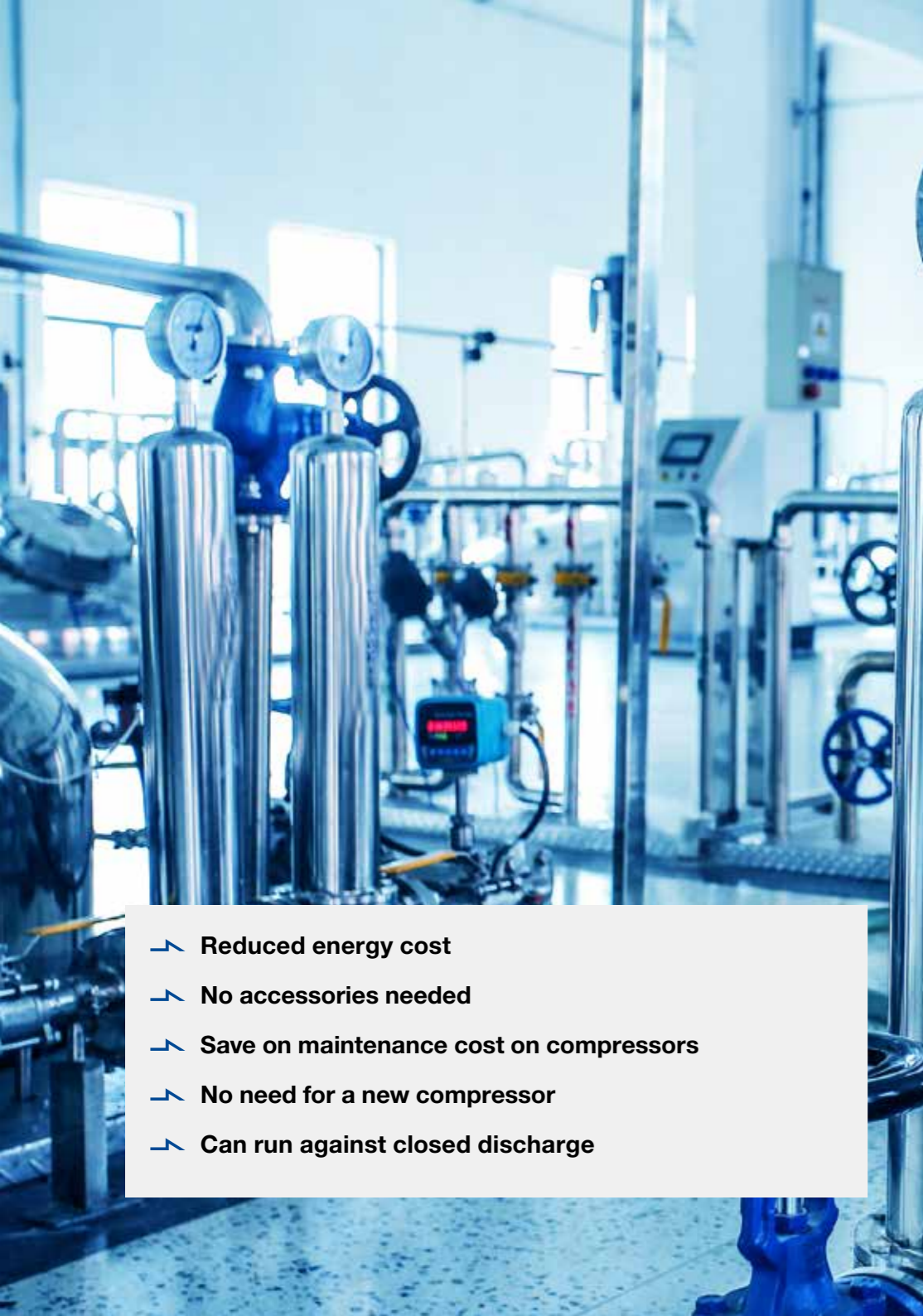

FROM AODD TO EODD

When choosing an EODD pump, you will save money because the total life cycle cost of an EODD pump is much lower than other pump technologies, including AODD. There are 3 typical situations to consider switching from AODD to EODD.

Situation A: No air available

When the operation site of the new pump doesn't have compressed air available. You can use the pump anywhere you want with the mobile execution.

Situation B: Reduce energy cost

With an EODD pump you save at least 80% on energy cost. At 84 l/min and 4 bar your savings will be more than 1.- Euro per hour. Each operating hour. Day by day, pump by pump.

Situation C: Avoid investment for a new compressor

If your compressor has reached its air limit and you need to think about a new one, consider the following. Reduce your air consumption with every EODD pump and release capacity for other air driven machines.

Of course there are several individual situations where a switch from AODD to EODD is interesting. These can vary from saving operational cost, saving on air consumption, or the desire to create a greener sustainable environment since an EODD operates with no leaks, preventing contamination and potential harm.

- **Reduced energy cost**
- **No accessories needed**
- **Save on maintenance cost on compressors**
- **No need for a new compressor**
- **Can run against closed discharge**

UP TO 80% SAVINGS USING AN EODD

An example: a customer pumps 84 litres per minute at a pressure of 4 bar with his traditional 1-inch AODD pump. With a Verderair VA25 that is almost identical in construction to the electric pump, he has a compressed air consumption of 1.12 Nm³/min. When used for 8 hours, this results in a consumption of 538 Nm³ per day. The price for the compressed air is approx. € 0.02 per Nm³. With a consumption of 538 Nm³ the cost for an AODD are € 10.75. The costs for pressure and leakage losses are already included.

In comparison, the electric VA-E 25 requires only 0.6 litres per day to fill the air cushion. A huge difference - and that on every day of operation! For energy comparison you have to calculate the power consumption: The EODD is equipped with a 1.5 kW motor. It consumes 11.2 kWh during eight hours of operation. The energy costs for this - calculated with an average of 17.20 Ct/kWh - are 1.81 € per day. € 10.75 compared to € 1.81 per day: in this typical application more than 83 % of the energy costs can be saved. For all your processes, day after day!



**Save up to 80%
of your energy cost**
at 8 h/day operation

Application examples (based on water) flow - pressure	100 l/min @ 2.5 bar	150 l/min – 6 bar	400 l/min – 2 bar
<i>Compared pumps</i>	VA25 vs. VA-E25	VA50 vs. VA-E50	VA50 vs. VA-E50
Air consumption AODD (Nm³/min)	0.93	1.40	1.98
Air consumption AODD 8h/day (Nm³)	446	672	950
Air costs AODD 8h/day (€)*	8.93	13.44	19.01
Power consumption EODD (kW)	1.3	2.5	3.2
Electricity costs EODD 8h/day (€)**	1.68	3.24	4.15
Total savings per day (€)	7.24	10.20	14.86
Total savings per pump (%)	81.1%	75.9%	78.2%

*€ 0.02 per Nm³ / **€ 0.162/kWh



To meet your most severe process conditions, yet still having a trouble-free operation, Verderair pumps have many material options for the valve seats, diaphragms & balls.

The combination of these high quality materials together with the choice of different housing materials give the optimum pump selection. EODD pumps are available in Stainless Steel, Aluminium and Polypropylene.

At the right page all material options for the diaphragms are listed. For heavy duty operations overmolded diaphragms are available in PTFE/EPDM and Neoprene. Especially with chemical aggressive fluids these diaphragms show an increased life, even up to 5 times. Thanks to the air cushion system there is less load on the diaphragms. This makes our EODD pumps more durable than other mechanical driven EODD pumps.

SAFETY

MOST RESISTANT MATERIALS

SAFE PUMPING OF YOUR CHEMICALS

The most aggressive chemicals are safely transferred by EODD pumps. Chemicals are often hazardous. It is therefore vital to select the best pump solution to maintain the highest safety and environmental standards. Verderair EODD pumps are fully sealed pump units. They are leak-proof, which makes them ideal for handling potentially hazardous fluids.

Verderair EODD pumps offer a safe environment. The pumps can run against closed discharge without the diaphragms being damaged. The pumps also have a long life time because there is no load on the diaphragms. With Verderair EODD pumps almost all chemicals can be pumped.

“Longer lifetime because less load on diaphragms”

Some examples of the pumped chemicals/liquids

SANTOPRENE	VITON	GEOLAST	NEOPRENE	EDPM/PTFE	BUNA	HYTREL
Ammonia water	Alcohol	Process water	Aluminium hydroxide	Acetone	Oils	Sodium borate
Urea	Aluminium Chloride	Waste water	Barium	Aluminumchloride	Propyl alcohol	Calcium chloride (brine)
Latex	Anti-Freeze	Oil	Boric acid	Ammonia liquids	Calcium Bisulfate	Glue
Molasses	Beet Sugar Liquids	Iron trichloride	Citric acid	Ethyl ether	Calgon	Grease (petroleum based)
Caustic soda	Brewery slop	Ethanol	Copper chloride	Nitric acid	Soy sauce	Methanol
	Lubricants		Ferric sulfate		Potash	Mineral oil
	Mayonnaise		Gelatine		Potassium Sulfate	Seawater
	Molasses		Glucose		Propane (liquified)	Sodium chloride
	Naptha		Glycerin		Salad dressing	
					Paraffin	

EODD SERIES - TECHNOLOGY ON THE SPOT

	VA-E25	VA-E50	Hygienic	
			VA-EH25	VA-EH50
Max. flow rate	148 l/min	378 l/min	133 l/min	378 l/min
Max. discharge pressure	4.8 bar	7 bar	4.8 bar	7 bar
Max. viscosity	10,000 cPs	20,000 cPs	10,000 cPs	20,000 cPs
Max. particle size	3.2 mm	6.3 mm	3.2 mm	6.3 mm
Temperature range	-40 - +104 °C	-40 - +104 °C	-40 - +104 °C	-40 - +104 °C
EC 1935/2004 / FDA			✓	✓
Internal surface roughness			3.2 µm	3.2 µm
Connexction sizes	1"	2"	1"	2"
ATEX	✓	✓	✓	✓
Housing materials	Aluminium, Stainless Steel, Polypropylene		Stainless Steel	Stainless Steel
	-	-	✓	✓

EODD SERIES - FLOW RATES AT A GLANCE

VA-E(H) 25

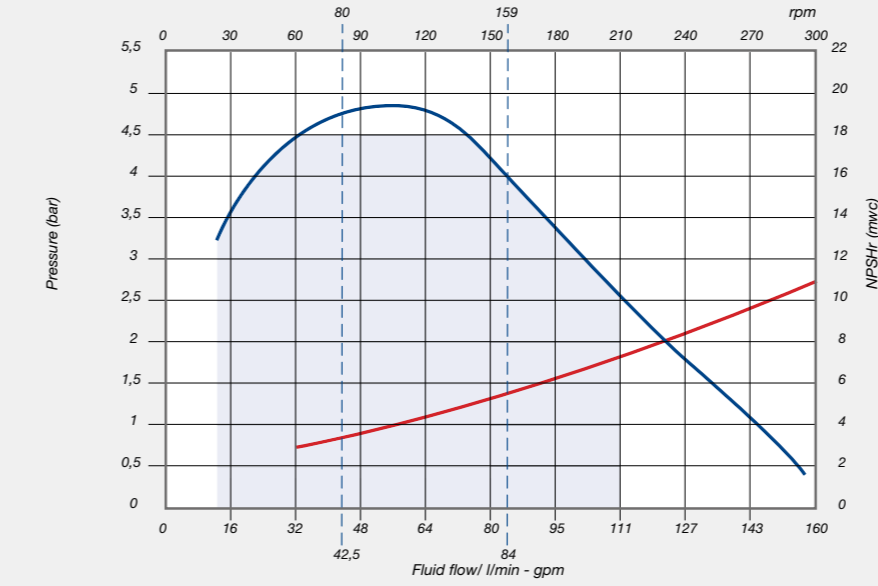

VA-E(H)50 option Ax, high speed gear ratio with 5K5 motor

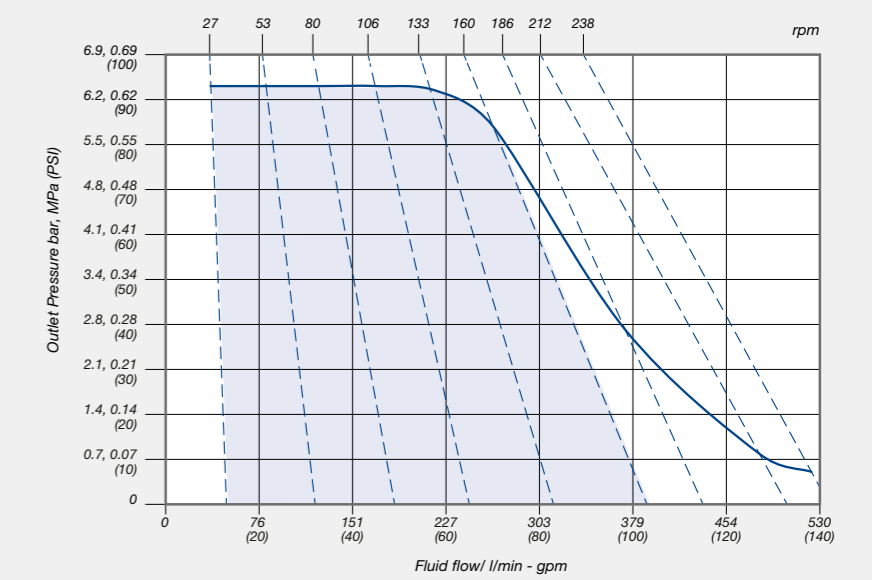

VA-E(H)50 option Bx, medium speed gear ratio with 4K motor

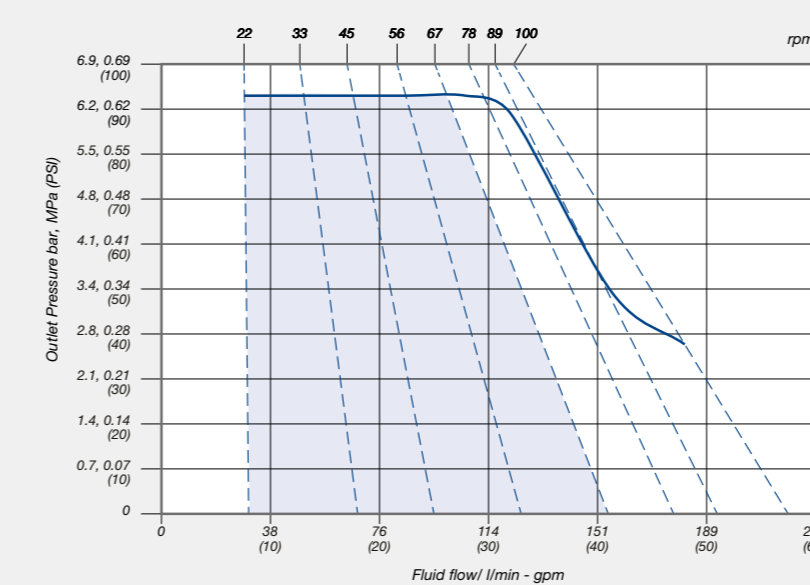

VA-E(H)50 option Cx, low speed gear ratio with 2K2 motor

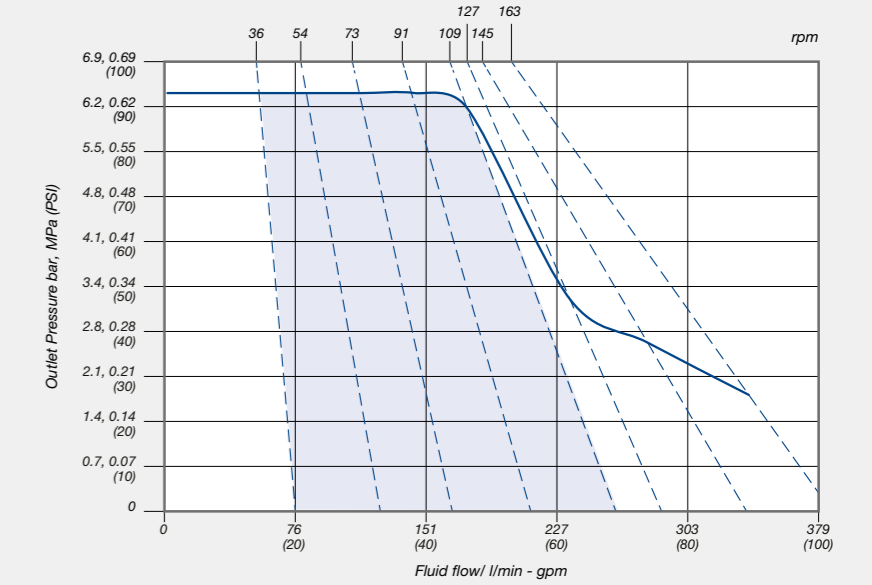



- ↳ Family owned
- ↳ > 1800 Employees
- ↳ Verder pumps sold in > 50 countries
- ↳ 11 Verder house brands
- ↳ Verder affiliated offices in 28 countries

THE VERDER GROUP

The story of the Verder Group began in 1959 when André Verder established a business in supplying pumps. André listened to his customer's needs and provided well-made and innovative product technology that worked for their process.

The Verder Group experienced rapid growth with its customer-led approach. In the subsequent 30 years, André and his son Andries took the Verder Group worldwide to the USA, Japan, China, India and South Africa with a far-reaching network of distributors. Today, Verder finds itself as an established supplier to many of the world's blue chip organizations for fluid handling and sample preparation of solids as well as analyzing technologies.

Verder Liquids

The Verder Group comprises two divisions, Verder Liquids and Verder Scientific. The Verder Liquids division manufactures pumps, mixers and systems. These pumps are distributed through 28 Verder offices, completed with a worldwide network of local distributors. Verder is offering local presence, local service and fast delivery times.

As a manufacturer, Verder is able to maintain the highest standards for the design, build and testing procedures, which reduces risk and costs to the customer. As a manufacturer, Verder is also able to translate requirements from the market into new products.

Our staff are skilled to know not only about pumps but also about your specific application. We listen to you, our customer, and we are experienced in finding the best pump solution for every application!

Verderair® is a registered trademark of the Verder Group.



CERAMICS

MUNICIPAL WASTE WATER



MARINE & FISHERIES



REFINERIES



PAINT & LACQUER



CHEMICAL INDUSTRY



DRINKING WATER PURIFICATION



PHARMACEUTICAL



AUTOMOTIVE

VERDER



passion for pumps

VERDER LIQUIDS BV

Utrechtseweg 4A
3451 GG Vleuten
The Netherlands

MAIL info@verder.com

WEB www.verderliquids.com

AUSTRIA / BELGIUM / BULGARIA / CHINA / CROATIA / CZECH REPUBLIC
FRANCE / GERMANY / HUNGARY / INDIA / ITALY / JAPAN / THE NETHERLANDS
POLAND / ROMANIA / SERBIA / SLOVAKIA / SLOVENIA / SOUTH AFRICA
SOUTH KOREA / SWITZERLAND / THAILAND / UNITED KINGDOM / USA