

VERDERFLEX®

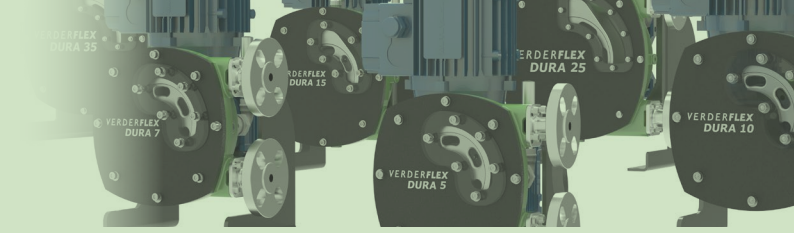

Peristaltic Industrial Hose Pump

Spare Parts List

Dura
5, 7, 10, 15, 25, 35

Version 2.2v-10/2020

Print-No. 01

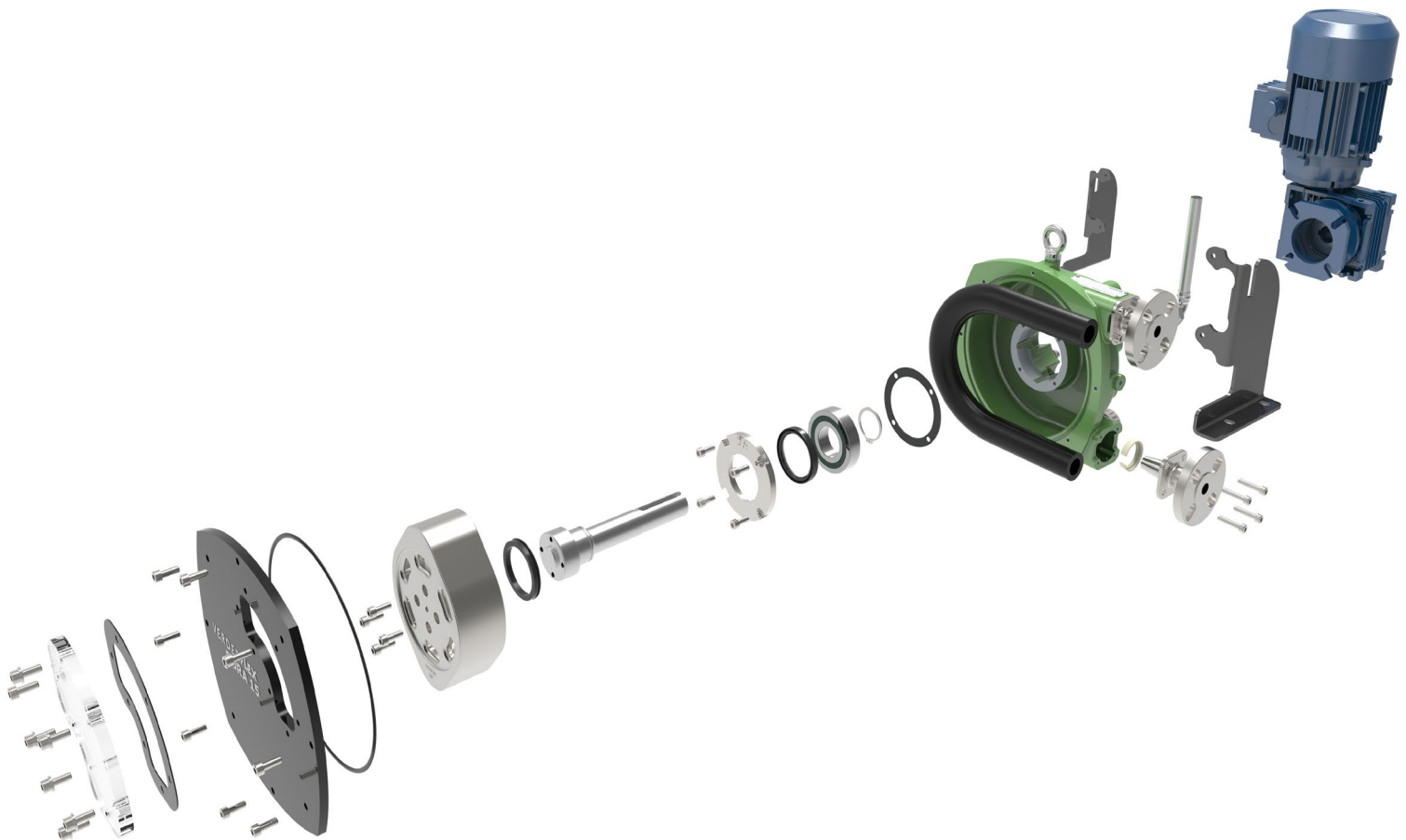

VERDER
passion for pumps



Version 2.2v-10/2020
Print-No. 01

Dura
5, 7, 10, 15, 25, 35

Dura MK IV 5 and 7 Spare Parts List

Table 1 contains a list of spares to help maintain and repair the Dura 05-35 peristaltic pumps. If in doubt, please contact your local Verder distributor with the pump serial number for genuine Verderflex® spares.

Pump Layout – Exploded view Dura MK IV 5 and 7

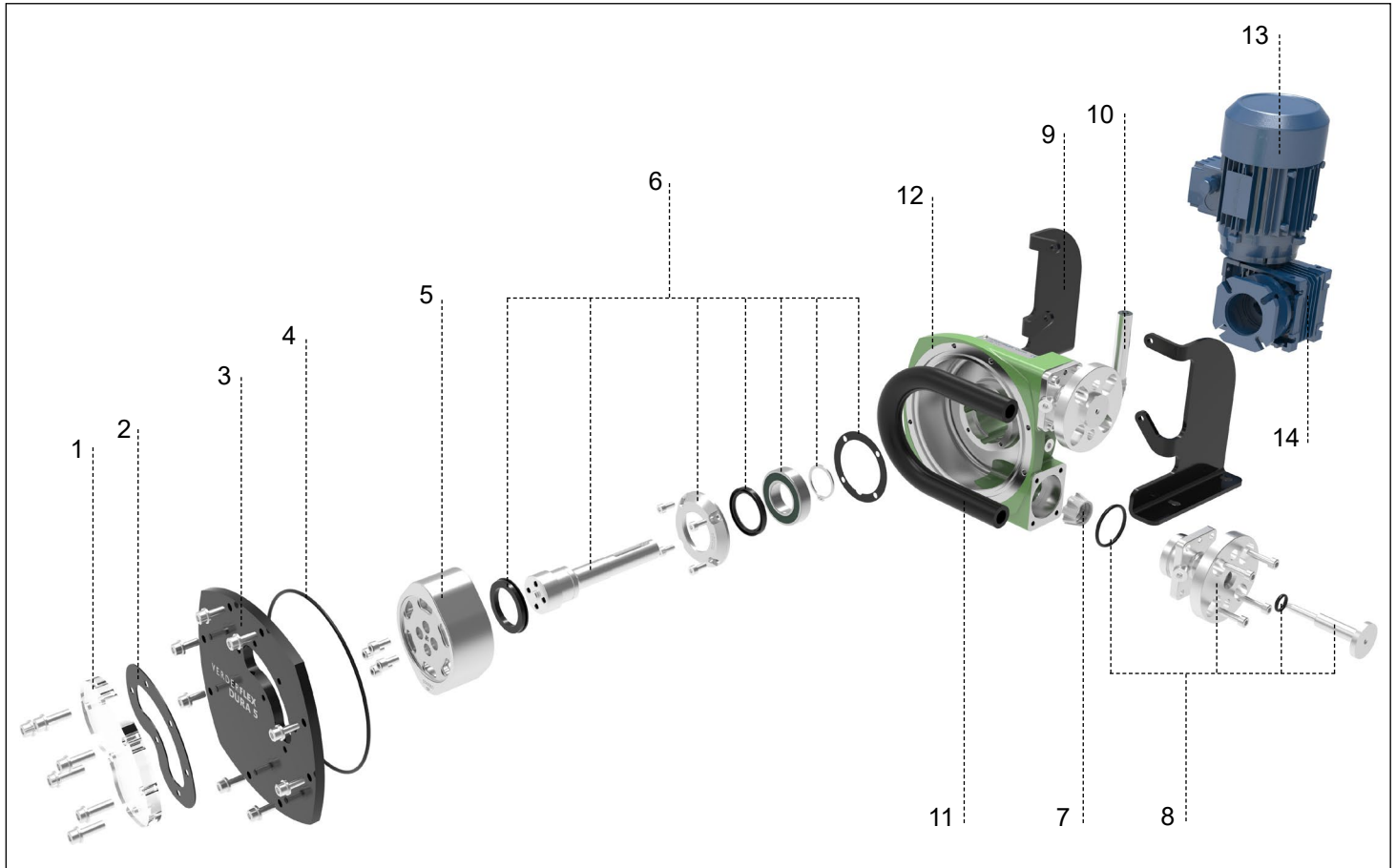

Figure 3 Dura MK IV 5 & 7 Exploded View (Generic View)

1	Inspection Window	6	Shaft Assembly	11	Hose
2	Inspection Window Gasket	7	Clamp Ring ¹⁾	12	Pump Housing
3	Front Cover	8	Port Flange ¹⁾	13	Gearbox with Adaptor Flange
4	O-Ring	9	Frames	14	Motor
5	Rotor	10	Filler Tube		



CAUTION

Ensure the spare parts (e.g hose, clamp ring and port flange) are installed as indicated in Dura 05-35 operating manual.

¹⁾ Applies for Dura MKIV 5 and 7 only. (→ refer to Dura 05-35 operating manual)

Dura MK III 10, 15, 25 and 35 Spare Parts List

Table 1 contains a list of spares to help maintain and repair the Dura 05-35 peristaltic pumps. If in doubt, please contact your local Verder distributor with the pump serial number for genuine Verderflex® spares.

Pump Layout – Exploded view Dura MK III 10, 15, 25 and 35

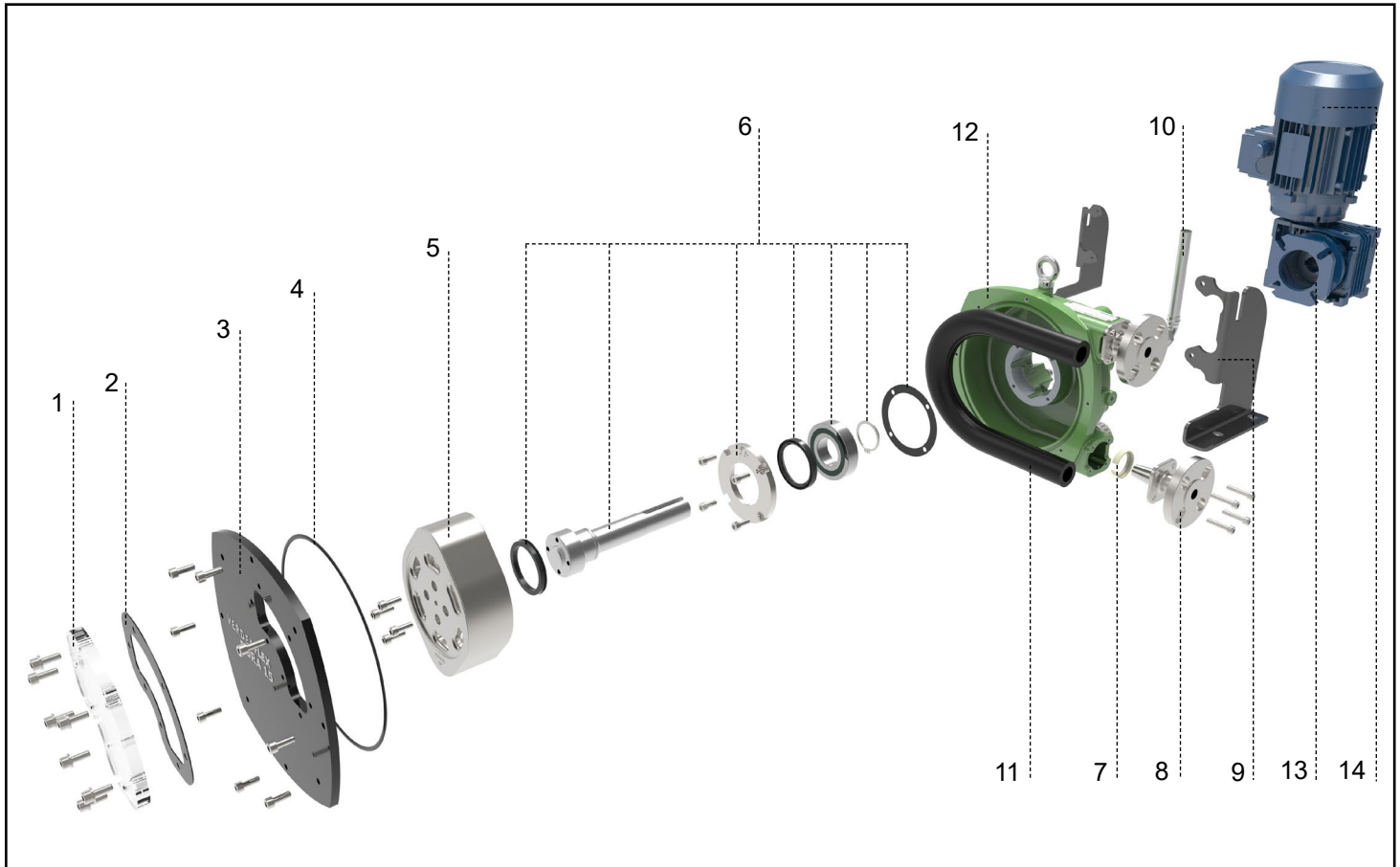

Figure 1 Layout - Dura MK III 10, 15, 25 and 35 Generic View

1	Inspection Window	6	Shaft Assembly	11	Hose
2	Inspection Window Gasket	7	Clamp Ring ¹⁾	12	Pump Housing ³⁾
3	Front Cover	8	Port Flange	13	Gearbox with Adaptor Flange
4	O-Ring	9	Frames	14	Motor
5	Rotor	10	Filler Tube ²⁾		



CAUTION

Ensure the spare parts (e.g hose, clamp ring and port flange) are installed as indicated in Dura 05-35 operating manual.

¹⁾ Applies only for D10, 15 and D35.

²⁾ For D25 and D35 use polypropylene filler tube instead of copper filler tube.

³⁾ Dura MK III pumps can be identified by the use of 4 mounting bolts on the rear drive boss rather than the single bolt design of earlier versions.

Table 1 Dura MK 05-35 Spare Parts List











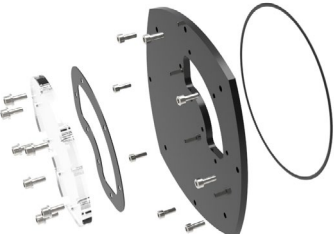

Ref	Item	Part No		Qty	Image
1.	Front Cover Inspection Window	D 5	139.2221.P	1	
		D 7	139.2221.P		
		D 10	139.2221.P		
		D 15	139.2222.P		
		D 25	139.2223.P		
		D 35	139.2224.P		
2.	Front Cover Inspection Window Gasket	D 5	139.2237	1	
		D 7	139.2237		
		D 10	139.2237		
		D 15	139.2235		
		D 25	139.2236		
		D 35	139.2233		
2.1	Front Cover Inspection Window and Gasket Assembly	D 5	139.2221.PA	1	
		D 7	139.2221.PA		
		D 10	139.2221.PA		
		D 15	139.2222.PA		
		D 25	139.2223.PA		
		D 35	139.2224.PA		
	Front Cover Inspection Window and Gasket Assembly for ATEX Rated Pumps	D 5	149.2227	1	
		D 7	149.2227		
		D 10	149.2227		
		D 15	149.2228		
		D 25	149.2229		
		D 35	149.2230		
3.	Front Cover	D 5	149.0178	1	
		D 7	149.0178		
		D 10	139.0139.S		
		D 15	139.0140.S		
		D 25	139.0141.S		
		D 35	139.0142		
3.1	Front Cover Assembly	D 5	149.0177	1	
		D 7	149.0177		
		D 10	139.1139		
		D 15	139.1140		
		D 25	139.1141		
		D 35	139.1142		

Table 1 Dura 05-35 Spare Parts List (continued)

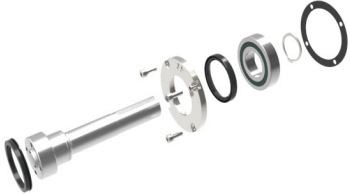
Ref	Item	Part No		Qty	Image	
4.	Front Cover O-ring	D 5	139.0075	1		
		D 7	139.0075			
		D 10	139.0075			
		D 15	139.0076			
		D 25	139.0077			
		D 35	139.0078			
5.	Rotor Assembly	Standard Pressure Rotor	D 5	149.0105	1	
			D 7	149.0105		
			D 10	149.0106		
			D 15	149.0107		
			D 25	149.0108		
			D 35	149.0109		
		High Pressure Rotor	D 5	149.0110		
			D 7	149.0110		
			D 10	149.0111		
			D 15	149.0112		
			D 25	149.0113		
			D 35	149.0114		
6.	Shaft Assembly (<i>complete with seals and bearings</i>)	D 5	149.0115	1		
		D 7	149.0115			
		D 10	149.0115			
		D 15	149.0116			
		D 25	149.0117			
		D 35*	149.0118			
6.1	Shaft Seal Assembly	D 5	149.0119	1		
		D 7	149.0119			
		D 10	149.0119			
		D 15	149.0120			
		D 25	149.0121			
		D 35*	149.0122			
6.2	Bearing and Seal Assembly	D 5	149.0123	1		
		D 7	149.0123			
		D 10	149.0123			
		D 15	149.0124			
		D 25	149.0125			
		D 35*	149.0126			

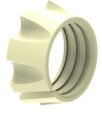
* For D35 use O-ring instead of gasket.

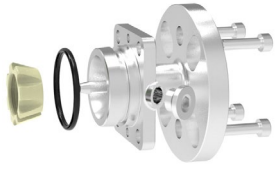
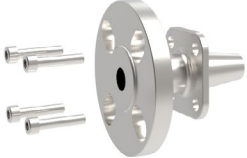
Table 1 Dura 05-35 Spare Parts List (continued)



Ref	Item	Part No	Qty	Image				
7.	Clamp Ring (Supplied as Flange seal- ing kit)	Pack of 4	D 5"	149.0185				
			D 7"					
		Single	D 10	139.2101	-			
		Pack of 5		139.2105				
		Pair	D 15	139.2106				
		Pair	D 25	Not required				
		Pair	D 35	139.1045				
8.***	Standard Flange (supplied in pairs)	SS	D 5"	149.0179				
		SS	D 7"	149.0182				
		SS	D 10	139.1334.A	1			
		PP****		obsolete				
		PVDF****	obsolete					
		SS	D 15	139.1335.A				
		PP****		obsolete				
		PVDF****	obsolete					
		SS	D 25	139.1336.A				
		PP****		obsolete				
		PVDF****	obsolete					
		SS	D 35	139.2237.A				
		PP****		Not available				
		PVDF****	Not available					
8.1***	Split Flange (option)		D 10	139.1334.B			1	
			D 15	139.1335.B				
			D 25	139.1336.B				
			D 35	139.1337.B				
	Split Flange Insert (supplied in pairs)	PP	D 10	139.2102	1			
		PVDF		139.2103				
		PP	D 15	139.2132				
		PVDF		139.2133				
PP	D 25	139.2142						
PVDF		139.2143						
PP	D 35	139.2182						
PVDF		139.2183						

** Applies for Dura MKIV 5 and 7 only.

*** For temperature limits, please check the datasheet.

**** For PP and PVDF contact parts use the split flange, plus insert design.

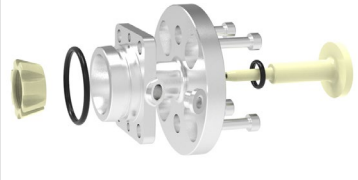
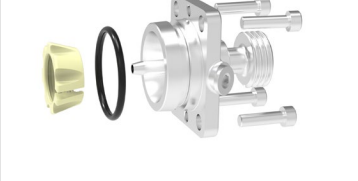
Table 1 Dura 05-35 Spare Parts List (continued)

Ref	Item	Part No	Qty	Image	
8.2***	Split Flange Assembly with Insert (supplied in pairs)	PP	D 5**	149.0180	
		PVDF		149.0181	
		PP	D 7**	149.0183	
		PVDF		149.0184	
		PP	D 10	139.2202	
		PVDF		139.2203	
		PP	D 15	139.2238	
		PVDF		139.2240	
		PP	D 25	139.2232	
		PVDF		139.2243	
		PP	D 35	139.2281	
		PVDF		139.2283	
	8.3	Hygienic Flange DIN11851 (supplied in pairs)	D 5	149.0205	
			D 7	149.0206	
D 10			149.0207		
D 15*****			149.0208		
			149.0209		
D 25			149.0210		
D 35*****	149.0211				
	149.0212				
8.2***	Hose tail assembly C/W fasteners (supplied in pairs)	D 5	-		
		D 7	-		
		D 10	139.1334.H		
		D 15	139.1335.H		
		D 25	-		
		D 35	-		

** Applies for Dura MKIV 5 and 7 only.

*** For temperature limits, please check the datasheet.

***** Please note that D15 and D35 hygienic flanges are available in two sizes.

Table 1 Dura 05-35 Spare Parts List (continued)





Ref	Item		Part No		Qty	Image
9.	Frames STD Height		D 5	149.0101	1	
			D 7	149.0101		
			D 10	149.0101		
			D 15	149.0102		
			D 25	149.0103		
			D 35	149.0104		
9.1	Frames LOW Height		D 5	149.0132	1	
			D 7	149.0132		
			D 10	149.0132		
			D 15	149.0133		
			D 25	149.0134		
			D 35	149.0135		
10.	Filler Tube	Metal	D 5	149.0759.D	1	
			D 7	149.0759.D		
			D 10	149.0759.D		
			D 15	149.0760		
		Polypropylene	D 25	149.0762		
			D 35	149.0761		
N/A	Drain Plug Kit		D 5	149.7010	1	
			D 7	149.7010		
			D 10	149.7010		
			D 15	149.0129		
			D 25	149.0129		
			D 35	149.0131		

Table 2 Dura 05-35 Parts for reference (not supplied as individual spares by Verderflex)





Item	Description		Image
Mounting Frame Fasteners	D 5, 7, 10, 15	M6 x 12 - 8.8 Steel BZP	
	D 25	M8 x 12 - 8.8 Steel BZP	
	D 35	M10 x 16 - 12.9 Steel BZP	
Rotor Screws	D 5, 7, 10	M6 x 12 - 8.8 Steel BZP CS	
	D 15	M6 x 16 - 8.8 Steel BZP	
	D 25	M8 x 16 - 8.8 Steel BZP	
	D 35	M8 x 20 - 12.9 Steel BZP CS	
Front Cover Screws	D 5, 7, 10, 15	M6 x 16 - 8.8 Steel BZP	
	D 25	M8 x 16 - 8.8 Steel BZP	
	D 35	M8 x 20 - 8.8 Steel BZP	
Port Flange Screws	D 5, 7, 10, 15	M6 x 30 - 12.9 Steel BZP	
	D 25, 35	M8 x 45 - 12.9 Steel BZP	
Inspection Window Screws	D 5, 7, 10, 15	M6 x 16 - 8.8 Steel BZP	
	D 25	M6 x 16 - 8.8 Steel BZP	
	D 35	M6 x 20 - 8.8 Steel BZP	

Table 3 Dura 05-35 Accessories





Item	Part No		Image
Revolution sensor	D 5, 7, 10, 15, 25, 35	129.0805	
Hose burst and vent kit	D 5, 7, 10, 15	149.0719	
	D 25	149.0722	
	D 35	149.0723	
Hose burst and vent kit for ATEX rated pumps	D 5, 7, 10, 15	149.0719.ATEX	-
	D 25	149.0721.ATEX	
	D 35	149.0720.ATEX	
Hose burst and vent kit for plastic filler tube	D 5	149.0859.HB	
	D 7	149.0859.HB	
	D 10	149.0859.HB	
	D 15	149.0860.HB	
	D 25	149.0860.HB	
	D 35	149.0861.HB	

Table 3 Dura 05-35 Accessories (continued)

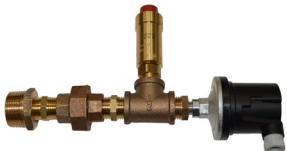
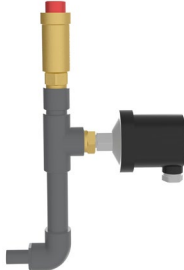

Item	Part No		Image
High Level Sensor Assembly	D 25	149.0721	
	D 35	149.0720	

Table 4 Dura 05-35 Hose Options





Item		Part No		Qty	Image
Hose option <i>NR/White</i>	singles	D 5	139.2080	1	
		D 7	139.2085		
		D 10	139.0001		
		D 15	139.0002		
		D 25	139.0003		
		D 35	139.0004		
Hose option <i>NBR/Yellow</i>	singles	D 5	139.2082	1	
		D 7	139.2087		
		D10	139.0512		
		D15	139.0513		
		D25	139.0514		
		D35	139.0515		
Hose option <i>NBRF/Yellow + White</i>	singles	D 5	-	1	
		D 7	-		
		D10	139.2021		
		D15	139.2022		
		D25	139.2023		
		D35	139.2024		
Hose option <i>Hypalon® / Green</i>	singles	D 5	139.2081	1	
		D 7	139.2086		
		D10	139.2010		
		D15	139.2011		
		D25	139.2012		
		D35	139.2013		
Hose option <i>EPDM/Red</i>	singles	D 5	-	1	
		D 7	-		
		D10	139.0010		
		D15	139.0011		
		D25	139.0012		
		D35	139.0013		
Hose option <i>Verderprene option/White</i>	singles	D 5	139.2030	1	
		D 7	-		
		D10	139.2031		
		D15	139.2032		
		D25	139.2033		
		D35	139.2034		

Table 5 Dura 05-35 Pump Lubricants

The pump must always be filled with the correct amount of lubricant to the middle level marks of the front cover. Table 5 shows the standard amount of lubricant supplied with Dura pumps in litres and US gallons.

Pump Size	Lubricant	Standard Quantity Supplied with Pump in Litre (US Gallons)	Part No
Dura 05	Verderlube® VerderSil®	0.5 (0.1)	129.1418 129.1372
Dura 07	Verderlube® VerderSil®	0.5 (0.1)	129.1418 129.1372
Dura 10	Verderlube® VerderSil®	0.5 (0.1)	129.1418 129.1372
Dura 15	Verderlube® VerderSil®	0.5 (0.1)	129.1418 129.1372
Dura 25	Verderlube® VerderSil®	2.0 (0.5)	129.1419 (Qty. 1Lx2) 129.1373 (Qty. 1Lx2)
Dura 35	Verderlube® VerderSil®	2.5 (0.7)	129.2379 129.2505

Trademarks

VERDERFLEX® is a registered trademark of Verder International B.V. No permission is granted to use any Verder, trademarks or trade names included in this document without the prior written agreement of Verder International B.V.

Tri-clamp® is a registered trademark of Alfa Laval Corporate AB.

Hypalon® is a registered trademark of RSCC Wire & Cable LLC.