

Gear pump with magnetic coupling

Original Operating Manual

VGS015...VGS2000 series

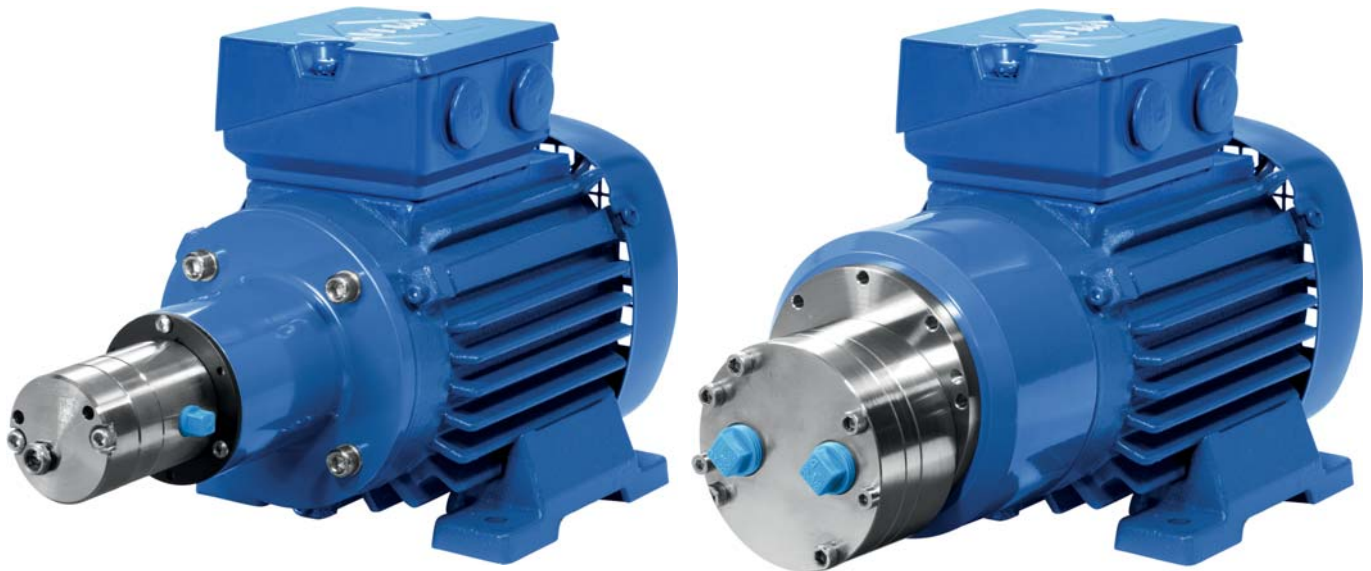

Version BA-2013.09
Print-No. 09/13

Verder Deutschland GmbH & Co. KG
Retsch-Allee 1 - 5
42781 Haan
Germany
Phone: +49 (0) 2104 2333-200
Fax: +49 (0) 2104 2333-299
E-Mail: info@verder.de
Internet: www.verder.de

We reserve the right to make technical changes.

Table of contents

1 About this document	5	5.3.6 Avoiding excessive pressure	16
1.1 Target groups	5	5.3.7 Providing safety and control devices (recommended)	17
1.2 Other applicable documents	5	5.4 Connecting the pipes	17
1.3 Warnings and symbols	6	5.4.1 Keeping the pipes clean	17
2 Safety	7	5.4.2 Installing the suction pipe	17
2.1 Intended use	7	5.4.3 Installing the pressure pipe	17
2.2 General safety instructions	7	5.5 Electrical connection	18
2.2.1 Product safety	7	5.5.1 Connecting the motor	18
2.2.2 Obligations of the operating company	7	5.5.2 Checking the direction of rotation	18
2.2.3 Obligations of personnel	8	6 Operation	19
2.3 Specific hazards	8	6.1 Putting the pump into service for the first time	19
2.3.1 Hazardous pumped liquids	8	6.1.1 Removing the preservative	19
2.3.2 Magnetic field	8	6.1.2 Adjusting the pressure relief valve	19
3 Layout and function	9	6.1.3 Filling and bleeding	19
3.1 Label	9	6.1.4 Checking the direction of rotation	19
3.2 Pump key	9	6.1.5 Switching on	20
3.3 Construction	10	6.1.6 Switching off	20
3.4 Bearings and lubrication	11	6.2 Operation	21
3.5 Shaft seal	11	6.2.1 Switching on	21
3.6 Signs and instructions	11	6.2.2 Switching off	21
4 Transport, storage and disposal	12	6.3 Shutting down the pump	22
4.1 Transport	12	6.4 Start-up following a shutdown period	22
4.1.1 Unpacking and inspection on delivery	12	6.5 Operating the stand-by pump	22
4.2 Treatment for storage	12	7 Maintenance	23
4.2.1 Applying preservative to the inside	12	7.1 Inspections	23
4.2.2 Applying preservative to the outside	12	7.2 Maintenance	24
4.3 Storage	13	7.2.1 Cleaning the pump	24
4.4 Removing the preservative	13	7.3 Repairs	24
4.5 Disposal	14	7.3.1 Dismounting the pump	24
5 Setup and connection	15	7.3.2 Returning the pump to the manufacturer	25
5.1 Preparing the setup	15	7.3.3 Installing	25
5.1.1 Check operating conditions	15	7.4 Ordering spare parts	25
5.1.2 Preparing the installation site	15	8 Troubleshooting	26
5.1.3 Preparing the foundation and surface	15	8.1 Pump malfunctions	26
5.1.4 Removing the preservative	15	8.2 Pressure relief valve malfunctions	29
5.2 Setup	15	9 Appendix	30
5.3 Planning the pipes	16	9.1 Sectional drawings	30
5.3.1 Specifying supports and flange connections	16	9.1.1 Parts list	30
5.3.2 Specifying nominal diameters	16	9.1.2 Sectional drawings	31
5.3.3 Specifying pipe lengths	16	9.2 Technical specifications	33
5.3.4 Optimizing changes in cross-section and direction	16	9.2.1 Pump data	33
5.3.5 Discharging leaks	16	9.2.2 Ambient conditions	33
		9.2.3 Sound pressure level	33

9.2.4	Tightening torques	33
9.2.5	Preservatives	33
9.2.6	Cleaning agents	33
9.3	Performance curves	34
9.4	Clearance certificate	39
9.5	Declaration of conformity according to EC Machine Directive	40

List of figures

Fig. 1	Pump key (example)	9
Fig. 2	Construction	10
Fig. 3	Straight pipe lengths upstream and downstream of the pump (recommended)	16
Fig. 4	Sectional drawing of VGS015-380 series	31
Fig. 5	Sectional drawing of VGS430-1300 series	32

List of tables

Tab. 1	Target groups and their duties	5
Tab. 2	Other applicable documents and their purpose	5
Tab. 3	Warnings and consequences of disregarding them	6
Tab. 4	Symbols and their meaning	6
Tab. 5	Pump type code	9
Tab. 6	Measures to be taken if the pump is shut down	22
Tab. 7	Measures depending on the behavior of the pumped liquid	22
Tab. 8	Measures for returning the pump	25
Tab. 9	Fault number assignment	26
Tab. 10	Pump troubleshooting list	28
Tab. 11	Fault number assignment	29
Tab. 12	Pressure relief valve troubleshooting list	29
Tab. 13	Designation of the components VGS015-380 series	30
Tab. 14	Designation of the components VGS430-1300 series	30
Tab. 15	Pump data	33
Tab. 16	Tightening torques	33
Tab. 17	Cleaning agents	33
Tab. 18	Clearance certificate	39
Tab. 19	Declaration of conformity according to EC Machine Directive	40

1 About this document

This manual:

- Is part of the pump
- Applies to the pump series mentioned above
- Describes safe and appropriate operation during all operating phases

1.1 Target groups

Target group	Duty
Operating company	<ul style="list-style-type: none"> ▶ Keep this manual available at the site of operation of the equipment, including for later use. ▶ Ensure that personnel read and follow the instructions in this manual and the other applicable documents, especially all safety instructions and warnings. ▶ Observe any additional rules and regulations referring to the system.
Qualified personnel, fitter	<ul style="list-style-type: none"> ▶ Read, observe and follow this manual and the other applicable documents, especially all safety instructions and warnings.





Tab. 1 Target groups and their duties

1.2 Other applicable documents



Document	Purpose
Dimension sheet	Pump dimensions
Sectional drawing	Sectional drawing, part numbers, component designations
Supplier documentation	Technical documentation for vendor parts (e.g. drive)
Declaration of conformity	Conformity with standards, contents of the declaration of conformity (→ 9.5 Declaration of conformity according to EC Machine Directive, Page 40).

Tab. 2 Other applicable documents and their purpose

1.3 Warnings and symbols

Warning	Risk level	Consequences of disregarding the warning
	Immediate acute risk	Death, serious injuries
	Potential acute risk	Death, serious injuries
	Potentially hazardous situation	Minor bodily harm
	Potentially hazardous situation	Material damage

Tab. 3 Warnings and consequences of disregarding them

Symbol	Meaning
	Safety warning sign ▶ Take note of all information highlighted by the safety warning sign and follow the instructions to avoid injury or death.
▶	Instruction
1. , 2. , etc.	Multiple-step instructions
✓	Precondition
→	Cross reference
	Information, notes

Tab. 4 Symbols and their meaning

2 Safety

 The manufacturer does not accept any liability for damages caused by disregarding the entire documentation.

2.1 Intended use

- Only use the pump for pumping the allowed pumped liquids (→ 9.2 Technical specifications, Page 33).
- Adhere to the operating limits.
- Avoid dry running:
 - Make sure the pump is only operated with pumped liquid, and never operated continuously without it.
- Avoid cavitation:
 - Fully open the suction-side fitting and do not use it to adjust the flow rate.
 - Open the pressure-side fitting completely.
- Avoid damage to the motor:
 - Note the maximum permissible number of times the motor can be switched on per hour (→ manufacturer's specifications).
- Consult the manufacturer about any other use of the pump.
- Pumps delivered without a motor must be assembled into a pump unit according to the provisions of EC Machine Directive 2006/42/EC.

Prevention of obvious misuse (examples)

- Note the operating limits of the pump with regard to temperature, pressure, viscosity, flow rate and motor speed. (→ 9.2 Technical specifications, Page 33).
- When using auxiliary systems, ensure there is a continuous supply of the appropriate operating medium.
- Do not operate the pump while the pressure-side fitting is closed.
- Pumps may not be used with foodstuffs if they have not been adapted accordingly. Usage with foodstuffs must be agreed with the manufacturer.
- Only select the setup type according to this operating manual. For example, the following are not allowed:
 - Hanging base plate pumps in the pipe
 - Overhead installation
 - Installation in the immediate vicinity of extreme heat or cold sources
 - Installation too close to the wall

2.2 General safety instructions

 Observe the following regulations before carrying out any work.

2.2.1 Product safety

The pump has been constructed according to the latest technology and recognized technical safety rules. Nevertheless, operation of the pump can still put the life and health of the user or third parties at risk or damage the pump or other property.

- Keep this manual and all other applicable documents complete, legible and accessible to personnel at all times.
- Refrain from any procedures and actions that would pose a risk to personnel or third parties.
- In the event of any safety-relevant malfunctions, shut down the pump immediately and have the malfunction corrected by the personnel responsible.
- In addition to the entire documentation for the product, comply with statutory or other safety and accident-prevention regulations and the applicable standards and guidelines in the country where the pump is operated.

2.2.2 Obligations of the operating company

Safety-conscious operation

- Only operate the pump if it is in perfect technical condition and only use it as intended, remaining aware of safety and risks, and adhere to the instructions in this manual.
- Ensure that the following safety aspects are observed and monitored:
 - Intended use
 - Statutory or other safety and accident-prevention regulations
 - Safety regulations governing the handling of hazardous substances
 - Applicable standards and guidelines in the country where the pump is operated
- Make personal protective equipment available.

Qualified personnel

- Make sure all personnel tasked with work on the pump have read and understood this manual and all other applicable documents, especially the safety, maintenance and repair information, before they start any work.
- Organize responsibilities, areas of competence and the supervision of personnel.

- Ensure that all work is carried out by specialist technicians only:
 - Fitting, repair and maintenance work
 - Work on the electrical system
- Make sure that trainee personnel only work on the pump under the supervision of specialist technicians.
- Persons who have an implanted pacemaker:
 - Must stay away from the pump with magnetic coupling and parts of the magnetic coupling
 - May not work on or with any of the magnetic parts

Safety equipment

- Provide the following safety equipment and verify its functionality:
 - For hot, cold and moving parts: on-site safety guards for the pump
 - For possible electrostatic charges: provide the necessary grounding
 - If there is no pressure relief valve in the pump: Provide a suitable pressure relief valve on the pressure side between the pump and the first shut-off device

Warranty

- Obtain the manufacturer's approval prior to carrying out any modifications, repairs or alterations during the warranty period.
- Only use genuine parts or parts that have been approved by the manufacturer.

2.2.3 Obligations of personnel

- All directions given on the pump must be followed (and kept legible), e.g. the flow direction arrow and the markings for fluid connections.
- Pump, coupling guard and components:
 - Do not step on them or use as a climbing aid
 - Do not use them to support boards, ramps or beams
 - Do not use them as a fixing point for winches or supports
 - Do not use them for storing paper or similar materials
 - Do not use hot pump or motor components as a heating point
 - Do not de-ice using gas burners or similar tools
- Do not remove the safety guarding for hot, cold or moving parts during operation.
- Use personal protective equipment whenever necessary.
- Only carry out work on the pump while it is not running.
- Isolate the motor from its supply voltage and secure it against being switched back on again when carrying out any fitting or maintenance work.
- Reinstall the safety equipment on the pump as required by regulations after any work on the pump.
- With an implanted pacemaker:
 - Stay at least 1 meter away from the pump with magnetic coupling or parts of the magnetic coupling.
 - Do not work with or on the magnetic parts.

2.3 Specific hazards

2.3.1 Hazardous pumped liquids

- Follow the safety regulations for handling hazardous substances when handling hazardous (e.g. hot, flammable, poisonous or potentially harmful) pumped liquids.
- Use personal protective equipment when carrying out any work on the pump.

2.3.2 Magnetic field

The magnetic field of the magnetic coupling can destroy products that are sensitive to magnets. These include:

- Pacemakers
- Plastic identity cards with magnetic strips
- Credit and check cards
- Electric, electronic and precision mechanical devices (such as mechanical and digital clocks, pocket calculators, hard disks)

3 Layout and function

VGS series gear pumps have been constructed for the low-pulsation pumping of non-corrosive pumped liquids. The integrated pressure relief valve protects the pump against damage caused by excess pressure.

3.1 Label

 The serial number and the pump key are engraved on the front side of the pump.

3.2 Pump key

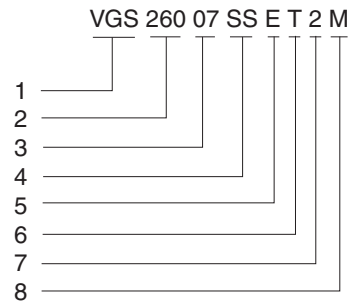

Fig. 1 Pump key (example)

Position	Meaning	
1	Series	
	VGS	Verder Gear Small
2	Flow [l/h]	
3	Pressure [bar]	
4	Housing material	
	SS	Stainless steel 1.4404
	HC	Hastelloy C
5	Gears and bearings material	
	E	PEEK
6	O-ring material	
	T	Teflon
	V	Viton
	N	Neoprene
7	Connections	
	1	1/8 "
	2	1/4 "
	3	3/8 "
	4	3/4 "
8	Bypass	
	M	with
	O	without

Tab. 5 Pump type code

3.3 Construction

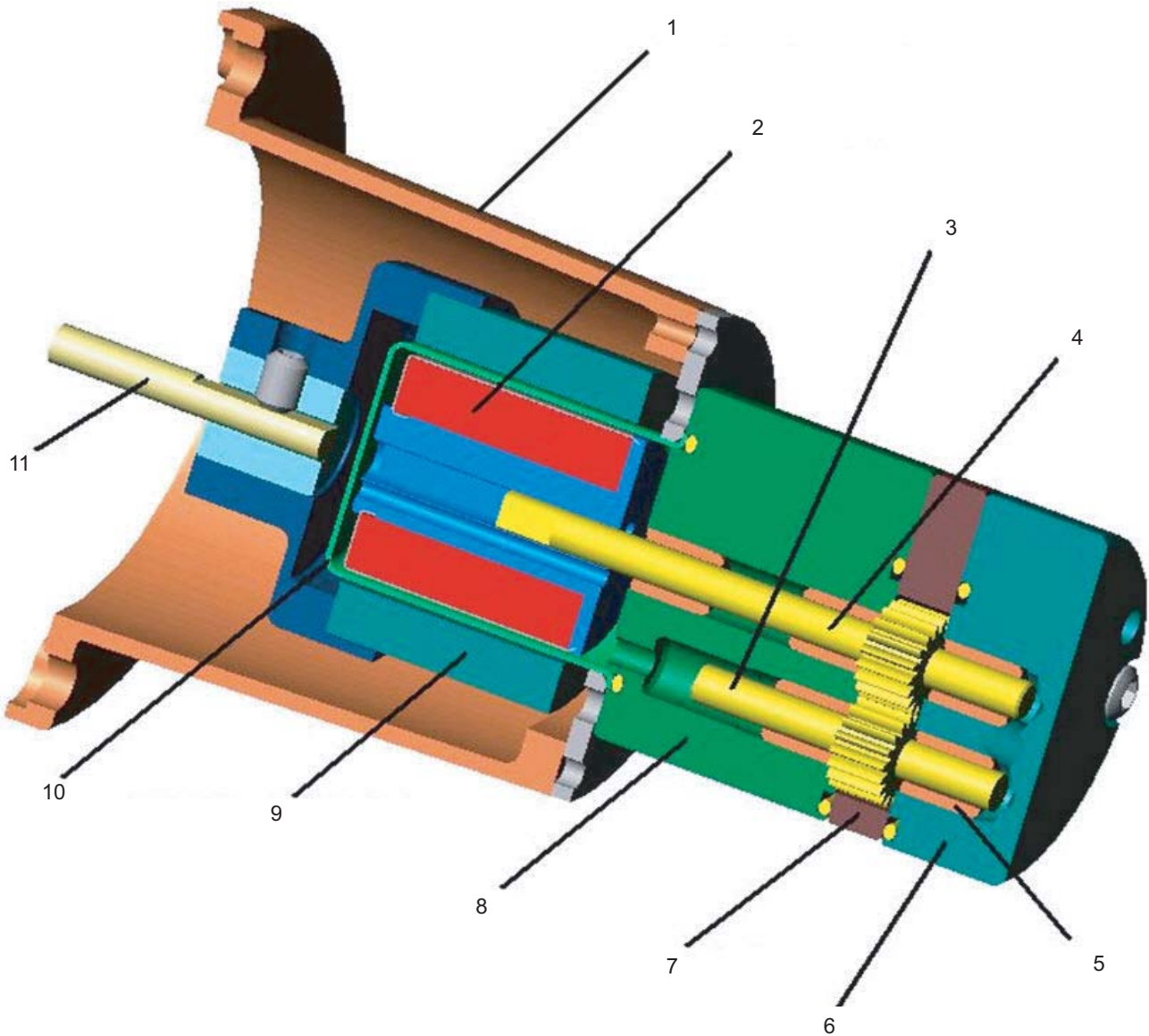

Fig. 2 Construction

- 1 Motor bracket
- 2 Inner rotor magnetic coupling
- 3 Driven gearwheel
- 4 Rotating gearwheel

- 5 Sleeve bearing
- 7 Cavitation plate
- 8 Pump motor housing
- 9 Outer rotor magnetic coupling

- 10 Separating can
- 11 Shaft

3.4 Bearings and lubrication

Pump: Internal sleeve bearing lubricated by pumped liquid.

3.5 Shaft seal

Hermetically sealed magnetic coupling.

3.6 Signs and instructions

The following signs or instructions are attached to the pump head:

- Flow direction arrow
- Date stamp

4 Transport, storage and disposal

4.1 Transport

 The pump unit can be lifted and transported by hand (weight < 15 kg).

DANGER

Risk of death and material damage due to magnetic field!

- ▶ Make sure that personnel who have a pacemaker fitted do not perform any work on the pump.
- ▶ Secure the work area. If necessary isolate the area:
 - Make sure that personnel with pacemakers keep a safe distance of at least 1 meter.
 - Make sure that no magnetizable metal parts can be attracted by the magnetic coupling of the pump.
 - Make sure that parts of the magnetic coupling cannot be attracted by the magnetizable metal parts.
- ▶ Keep all magnetically-sensitive objects at a safe distance of at least 150 mm from the magnetic coupling.

4.1.1 Unpacking and inspection on delivery

1. Unpack the pump/unit on delivery and inspect it for transport damage.
2. Report any transport damage to the manufacturer immediately.
3. Dispose of packaging material according to local regulations.

4.2 Treatment for storage

 The pump has not been treated for storage at the factory.
Treatment is not necessary for non-rusting materials.

WARNING

Danger of poisoning or contamination due to preservatives!

- ▶ Only use a preservative which is compatible with the pumped liquid (→ 9.2.6 Cleaning agents, Page 33).

NOTE

Material damage due to inappropriate treatment for storage!

- ▶ Treat the pump properly, inside and outside, for storage.

4.2.1 Applying preservative to the inside

1. Close the suction connection with a blank flange.
2. Fill the pump via the pressure connection with preservative (e.g. RUST-BAN 335).
3. Turn the shaft slowly against the pump's sense of rotation.
4. Continue filling and turning until no bubbles emerge from the pressure connection.
5. Close the pressure connection with a blank flange.
6. Every 6 months:
 - Renew the preservative if necessary.

4.2.2 Applying preservative to the outside

1. Apply preservative to all bare metal parts.
2. Every 6 months:
 - Renew the preservative if necessary.

4.3 Storage

⚠ DANGER

Risk of death and material damage due to magnetic field!

- ▶ Make sure that personnel who have a pacemaker fitted do not perform any work on the pump.
- ▶ Secure the work area. If necessary isolate the area:
 - Make sure that personnel with pacemakers keep a safe distance of at least 1 meter.
 - Make sure that no magnetizable metal parts can be attracted by the magnetic coupling of the pump.
 - Make sure that parts of the magnetic coupling cannot be attracted by the magnetizable metal parts.
- ▶ Keep all magnetically-sensitive objects at a safe distance of at least 150 mm from the magnetic coupling.

NOTE

Material damage due to inappropriate storage!

- ▶ Treat and store the pump properly.
1. Seal all openings with blank flanges, blind plugs or plastic covers.
 2. Make sure the storage room meets the following conditions:
 - Dry
 - Frost-free
 - Vibration-free
 - Dust-free
 - Ambient conditions are met (→ 9.2.2 Ambient conditions, Page 33).
 3. Turn the shaft once a month.

4.4 Removing the preservative

i Only necessary for pumps treated for storage.

NOTE

High water pressure or spray water can damage bearings!

- ▶ Do not clean bearing areas with a water or steam jet.

NOTE

Damage to seals due to wrong cleaning agents!

- ▶ Ensure the cleaning agent does not corrode the seals.
1. Choose the cleaning agent to suit the area of application (→ 9.2.6 Cleaning agents, Page 33).
 2. Remove the preservative from all bare internal parts of the pump.
 3. Dispose of cleaning agents in accordance with local regulations.
 4. For storage times in excess of 6 months:
 - Replace the elastomer parts made of EP rubber (EPDM).
 - Check all elastomer parts (O-rings, shaft seals) for proper elasticity and replace them if necessary.

4.5 Disposal

 Plastic parts can be contaminated by poisonous or radioactive pumped liquids to such an extent that cleaning will be insufficient.

DANGER

Risk of death and material damage due to magnetic field!

- ▶ Make sure that personnel who have a pacemaker fitted do not perform any work on the pump.
- ▶ Secure the work area. If necessary isolate the area:
 - Make sure that personnel with pacemakers keep a safe distance of at least 1 meter.
 - Make sure that no magnetizable metal parts can be attracted by the magnetic coupling of the pump.
 - Make sure that parts of the magnetic coupling cannot be attracted by the magnetizable metal parts.
- ▶ Keep all magnetically-sensitive objects at a safe distance of at least 150 mm from the magnetic coupling.

WARNING

Risk of poisoning and environmental damage by the pumped liquid or oil!

- ▶ Use personal protective equipment when carrying out any work on the pump.
 - ▶ Prior to the disposal of the pump:
 - Collect and dispose of any escaping pumped liquid or oil in accordance with local regulations.
 - Neutralize residues of pumped liquid in the pump.
 - Removing the preservative (→ 4.4 Removing the preservative, Page 13).
 - ▶ Remove the plastic parts and dispose of them in accordance with local regulations.
-
- ▶ Dispose of the pump in accordance with local regulations.

5 Setup and connection

DANGER

Risk of death and material damage due to magnetic field!

- ▶ Make sure that personnel who have a pacemaker fitted do not perform any work on the pump.
- ▶ Secure the work area. If necessary isolate the area:
 - Make sure that personnel with pacemakers keep a safe distance of at least 1 meter.
 - Make sure that no magnetizable metal parts can be attracted by the magnetic coupling of the pump.
 - Make sure that parts of the magnetic coupling cannot be attracted by the magnetizable metal parts.
- ▶ Keep all magnetically-sensitive objects at a safe distance of at least 150 mm from the magnetic coupling.

NOTE

Material damage due to distortion or passage of electrical current in the bearing!

- ▶ Do not make any structural modifications to the pump unit or pump casing.
- ▶ Do not carry out any welding work on the pump unit or pump casing.

NOTE

Material damage caused by dirt!

- ▶ Do not remove any covers or transport and screw plugs until immediately before connecting the pipes to the pump.

5.1 Preparing the setup

5.1.1 Check operating conditions

1. Ensure the pump data is adhered to (→ 9.2.1 Pump data, Page 33).
2. Make sure the required ambient conditions are fulfilled (→ 9.2.2 Ambient conditions, Page 33).

5.1.2 Preparing the installation site

- ▶ Ensure the installation site meets the following conditions:
 - Pump is freely accessible from all sides
 - Sufficient space for the installation/removal of the pipes and for maintenance and repair work, especially for the removal and installation of the pump and the motor
 - Pump not exposed to external vibrations (damage to bearings)
 - Frost protection

5.1.3 Preparing the foundation and surface

- ▶ Make sure the foundation and surface fulfill the following requirements:
 - Level
 - Clean (no oil, dust or other impurities)
 - Capable of bearing the weight of the pump unit and all operating forces
 - The pump is stable and cannot tip over
 - With concrete foundation: Standard concrete of strength class B 25

5.1.4 Removing the preservative

- ▶ If the pump is to be put into operation immediately after setup and connection: Remove the preservative prior to installation (→ 4.4 Removing the preservative, Page 13).

5.2 Setup

1. Lift the pump unit (→ 4.1 Transport, Page 12).
2. Place down the pump unit at its installation location.
3. Screw in the fastening bolts on the foot of the motor and tighten them (→ 9.2.4 Tightening torques, Page 33).

5.3 Planning the pipes

5.3.1 Specifying supports and flange connections

NOTE

Material damage due to excessive forces and torques exerted by the piping on the pump!

- ▶ Do not exceed the permissible values (→ flange loads according to EN ISO 14847).

1. Calculate the pipe forces, taking every possible operating condition into account:
 - Cold/warm
 - Empty/full
 - Depressurized/pressurized
 - Positional changes of the flanges
2. Ensure the pipe supports have permanent low-friction properties and do not seize up due to corrosion.

5.3.2 Specifying nominal diameters

- ⓘ Keep the flow resistance in the pipes as low as possible.

1. Make sure the nominal suction pipe diameter is \geq to the nominal suction connection diameter.
 - Make sure the flow rate is below 1.5 m/s
2. Make sure the nominal pressure pipe diameter is \geq to the nominal outlet connection diameter.
 - Make sure the flow rate is below 3.0 m/s

5.3.3 Specifying pipe lengths

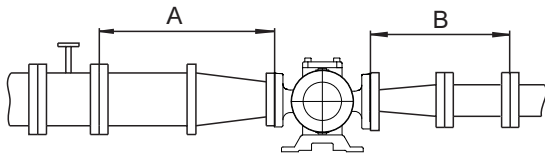

Fig. 3 Straight pipe lengths upstream and downstream of the pump (recommended)

- A > 5 x nominal suction pipe diameter
 B > 5 x nominal pressure pipe diameter

- ▶ Maintain the recommended minimum values when installing the pump.

- ⓘ Suction side: Shorter pipes are possible but may restrict the hydraulic performance.
 Pressure side: Shorter pipes are possible but can result in increased operating noise.

5.3.4 Optimizing changes in cross-section and direction

1. Avoid bending radii of less than 1.5 times the nominal pipe diameter.
2. Avoid abrupt changes of cross-section and direction along the piping.

5.3.5 Discharging leaks

WARNING

Risk of injury and poisoning due to hazardous pumped liquids!

- ▶ Safely collect any leaking pumped liquid, then discharge and dispose of it in accordance with environmental regulations.

1. Provide equipment for collecting and discharging leaking liquids.
2. Ensure the free discharge of leaking liquids.

5.3.6 Avoiding excessive pressure

WARNING

Risk of injury due to excessive pressure!

- ▶ If there is no pressure relief valve in the pump: Provide a suitable pressure relief valve in the pressure line.

1. Observe the operating instructions of the manufacturer.
2. Make sure the factory setting of the pressure relief valve meets the requirements of the system.
3. Do **not** feed the return flow of the safety valve directly back into the suction pipe.

5.3.7 Providing safety and control devices (recommended)

Avoid impurities

1. Install a dirt trap in the suction pipe (mesh size $\leq 25 \mu\text{m}$).
2. To monitor impurities, install a differential pressure gauge with contact pressure gauge.

Making provisions for isolating and shutting off pipes



For maintenance and repair work.

- ▶ Provide shut-off devices in the suction and pressure pipes.

Allowing measurement of the operating conditions

1. Provide pressure gauges for measurements in the suction and pressure pipes.
2. Provide for suction-side temperature measurements.

Monitoring leaks



Only necessary for hot or hazardous pumped liquids.

1. Provide leak monitoring equipment.
2. Safely collect major leakages (e.g. following a seal malfunction) and dispose of them.

5.4 Connecting the pipes

5.4.1 Keeping the pipes clean

NOTE

Material damage due to impurities in the pump!

- ▶ Make sure no impurities can enter the pump.
-

1. Flush all pipe parts and fittings prior to assembly.
2. Make sure no seals protrude inwards.
3. Remove any blank flanges, plugs, protective foils and/or protective paint from the flanges.
4. On welded pipes: Remove the welding beads.

5.4.2 Installing the suction pipe

1. Make sure that the thread of the suction pipe and suction connection correspond.
2. Remove the transport and screw plugs from the pump.
3. Always install the suction pipe at an incline:
 - Wrap thread sealant (e.g. Teflon tape) around the thread
 - Screw in the suction pipe at least two turns and max. 5 turns manually
 - Hold the pump head while turning in

5.4.3 Installing the pressure pipe

1. Make sure that the thread of the pressure line and pressure connection correspond.
2. Remove the transport and screw plugs from the pump.
3. Always install the pressure line at an incline:
 - Wrap thread sealant (e.g. Teflon tape) around the thread
 - Screw in the pressure line at least two turns and max. 5 turns manually
 - Hold the pump head while turning in

5.5 Electrical connection

DANGER

Risk of electrocution!

- ▶ Have all electrical work carried out by qualified electricians only.

5.5.1 Connecting the motor

 Follow the instructions of the motor manufacturer.

1. Connect the motor according to the connection diagram.
2. Make sure no danger arises due to electric power.
3. Install an EMERGENCY STOP switch.

5.5.2 Checking the direction of rotation

 This is only possible when the pump starts operation (→ 6.1 Putting the pump into service for the first time, Page 19).

6 Operation

DANGER

Risk of death and material damage due to magnetic field!

- ▶ Make sure that personnel who have a pacemaker fitted do not perform any work on the pump.
- ▶ Secure the work area. If necessary isolate the area:
 - Make sure that personnel with pacemakers keep a safe distance of at least 1 meter.
 - Make sure that no magnetizable metal parts can be attracted by the magnetic coupling of the pump.
 - Make sure that parts of the magnetic coupling cannot be attracted by the magnetizable metal parts.
- ▶ Keep all magnetically-sensitive objects at a safe distance of at least 150 mm from the magnetic coupling.

6.1 Putting the pump into service for the first time

6.1.1 Removing the preservative

 Only necessary for pumps treated for storage.

- ▶ (→ 4.4 Removing the preservative, Page 13).

6.1.2 Adjusting the pressure relief valve

1. Set the integrated pressure relief valve in accordance with the demands of the system:
 - Turn the setting screw counterclockwise: Pressure limit drops
 - Turn the setting screw clockwise: Pressure limit rises
2. Make sure the safety valve on the system side meets the requirements of the pump.

6.1.3 Filling and bleeding

WARNING

Risk of injury and poisoning due to hazardous pumped liquids!

- ▶ Safely collect any leaking pumped liquid and dispose of it in accordance with environmental rules and requirements.

1. Open the suction-side fitting.
2. Fill the pump and suction pipe with pumped liquid until pumped liquid escapes without bubbles.
3. Open the pressure-side fitting.
4. Ensure that no pipe connections are leaking.

6.1.4 Checking the direction of rotation

- ✓ Pump prepared, filled and bled properly

DANGER

Risk of injury due to running pump!

- ▶ Do not touch the running pump.
- ▶ Do not carry out any work on the running pump.
- ▶ Allow the pump to cool down completely before starting any work.

1. Open the pressure-side fitting.
2. Open the suction-side fitting.
3. Switch the motor on and immediately off again.
4. Check whether the flow direction arrow of the pump corresponds with the flow direction.
5. If the sense of rotation is different:
 - Swap two phases (→ 5.5.1 Connecting the motor, Page 18).

6.1.5 Switching on

- ✓ Pump set up and connected properly
- ✓ Motor set up and connected properly
- ✓ All connections stress-free and sealed
- ✓ All safety equipment installed and tested for functionality
- ✓ Pump prepared, filled and bled properly

DANGER

Risk of injury due to running pump or hot pump parts!

- ▶ Do not touch the running pump.
- ▶ Do not carry out any work on the running pump.
- ▶ Allow the pump to cool down completely before starting any work.

DANGER

Risk of injury and poisoning due to pumped liquid spraying out!

- ▶ Use personal protective equipment when carrying out any work on the pump.

NOTE

Risk of cavitation when throttling down the suction flow rate!

- ▶ Fully open the suction-side fitting and do not use it to adjust the flow rate.

NOTE

Material damage due to excessive pressure!

- ▶ Do not operate the pump while the pressure-side fitting is closed.

NOTE

Material damage caused by dry running!

- ▶ Make sure the pump is filled properly.
1. Open the pressure-side fitting.
 2. Open the suction-side fitting.
 3. Switch on the motor and make sure it is running smoothly.
 4. Make sure the temperature rises at a rate of no more than 2 K/min.
 5. Flush the pump for approx. 1 minute with pumped liquid to remove residues from the inside of the pump.
 6. After the first load under pressure and at operating temperature, check that the pump is not leaking.

6.1.6 Switching off

WARNING

Risk of injury due to hot pump parts!

- ▶ Use personal protective equipment when carrying out any work on the pump.

NOTE

Material damage due to deposits!

- ▶ If the pumped liquid has crystallized, polymerized or solidified
 - Flush the pump
 - Ensure that the flushing medium is compatible with the pumped liquid
1. Switch off the motor.
 2. If there is no non-return fitting in the pressure line: close the pressure-side fitting.
 3. If necessary: Flush and empty the pump.
 4. Check all connecting bolts and tighten them if necessary.

6.2 Operation

6.2.1 Switching on

- ✓ Pump initially put into service properly
- ✓ Pump filled and bled

DANGER

Risk of injury due to running pump or hot pump parts!

- ▶ Do not touch the running pump.
- ▶ Do not carry out any work on the running pump.
- ▶ Allow the pump to cool down completely before starting any work.

DANGER

Risk of injury and poisoning due to pumped liquid spraying out!

- ▶ Use personal protective equipment when carrying out any work on the pump.

NOTE

Risk of cavitation when throttling down the suction flow rate!

- ▶ Fully open the suction-side fitting and do not use it to adjust the flow rate.

NOTE

Material damage caused by dry running!

- ▶ Make sure the pump is filled properly.
1. Open the pressure-side fitting.
 2. Open the suction-side fitting.
 3. Switch on the motor and make sure it is running smoothly.
 4. Make sure the temperature rises at a rate of no more than 2 K/min.

6.2.2 Switching off

WARNING

Risk of injury due to hot pump parts!

- ▶ Use personal protective equipment when carrying out any work on the pump.

NOTE

Material damage due to deposits!

- ▶ If the pumped liquid has crystallized, polymerized or solidified
 - Flush the pump
 - Ensure that the flushing medium is compatible with the pumped liquid

1. Switch off the motor.
2. If there is no non-return fitting in the pressure line: close the pressure-side fitting.
3. If necessary: Flush and empty the pump.

6.3 Shutting down the pump

⚠ WARNING

Risk of injury and poisoning due to hazardous pumped liquids!

- ▶ Safely collect any leaking pumped liquid and dispose of it in accordance with environmental rules and requirements.
-
- ▶ Take the following measures whenever the pump is shut down:

Pump is	Measure
...shut down for a prolonged period	▶ Perform appropriate measures for the pumped liquid (→ Table 7 Measures depending on the behavior of the pumped liquid, Page 22).
...emptied	▶ Close the suction-side and pressure-side fittings.
...dismounted	▶ Isolate the motor from its power supply and secure it against unauthorized switch-on.
...put into storage	▶ Observe the storage instructions (→ 4.3 Storage, Page 13).

Tab. 6 Measures to be taken if the pump is shut down

Behavior of the pumped liquid	Duration of shutdown (depending on process)	
	Short	Long
Sediments, crystallizes, polymerizes or solidifies	▶ Flush the pump	▶ Flush the pump
Solidifying/ freezing, non-corrosive	▶ Heat up or empty the pump and containers.	▶ Empty the pump and containers.
Solidifying/ freezing, corrosive	▶ Heat up or empty the pump and containers.	▶ Empty the pump and containers. ▶ Treat the pump and containers with preservative.
Remains liquid, non-corrosive	–	–
Remains liquid, corrosive	–	▶ Empty the pump and containers. ▶ Treat the pump and containers with preservative.

Tab. 7 Measures depending on the behavior of the pumped liquid

6.4 Start-up following a shutdown period

1. If the pump is shut down for over 6 months, take the following measures before starting it up again:
 - Replace the elastomer seals (O-rings, shaft seal rings).
 - If necessary: Replace the motor bearing (→ operating manual of the motor manufacturer).
2. Carry out the same steps as for the initial start-up (→ 6.1 Putting the pump into service for the first time, Page 19).

6.5 Operating the stand-by pump

- ✓ Stand-by pump filled and bled
- ▶ Operate the stand-by pump at least once a week.

7 Maintenance

 Trained service technicians are available for fitting and repair work.

Present a pumped liquid certificate (DIN safety data sheet or safety certificate) when requesting service.

DANGER

Risk of death and material damage due to magnetic field!

- ▶ Make sure that personnel who have a pacemaker fitted do not perform any work on the pump.
- ▶ Secure the work area. If necessary isolate the area:
 - Make sure that personnel with pacemakers keep a safe distance of at least 1 meter.
 - Make sure that no magnetizable metal parts can be attracted by the magnetic coupling of the pump.
 - Make sure that parts of the magnetic coupling cannot be attracted by the magnetizable metal parts.
- ▶ Keep all magnetically-sensitive objects at a safe distance of at least 150 mm from the magnetic coupling.

DANGER

Risk of injury due to running pump or hot pump parts!

- ▶ Do not touch the running pump.
- ▶ Do not carry out any work on the running pump.
- ▶ Allow the pump to cool down completely before starting any work.

WARNING

Risk of injury and poisoning due to hazardous pumped liquids!

- ▶ Use personal protective equipment when carrying out any work on the pump.

7.1 Inspections

 The inspection intervals depend on the operational strain on the pump.

1. Check at appropriate intervals:
 - Normal operating conditions unchanged
 - Check whether the pressure relief valve is working
2. For trouble-free operation, always ensure the following:
 - No dry running
 - No leaks
 - No cavitation
 - Suction-side fittings open
 - Unclogged and clean filters
 - No unusual running noises or vibrations

7.2 Maintenance

DANGER

Risk of electrocution!

- ▶ Have all electrical work carried out by qualified electricians only.

7.2.1 Cleaning the pump

NOTE

High water pressure or spray water can damage bearings!

- ▶ Do not clean bearing areas with a water or steam jet.
- ▶ Clean large-scale grime from the pump.

7.3 Repairs

DANGER

Risk of electrocution!

- ▶ Have all electrical work carried out by qualified electricians only.

WARNING

Risk of injury due to heavy components!

- ▶ Pay attention to the component weight. Lift and transport heavy components using suitable lifting gear.
- ▶ Set down components safely and secure them against overturning or rolling away.

7.3.1 Dismounting the pump

- ✓ Pump depressurized
- ✓ Pump completely empty, flushed and decontaminated
- ✓ Electrical connections disconnected and motor secured against being switched on again
- ✓ Pump cooled down
- ✓ Auxiliary systems shut down, depressurized and emptied
- ✓ Pressure gauge lines, pressure gauge and holdings dismantled

WARNING

Risk of injury during disassembly!

- ▶ Secure the pressure-side fitting against accidental opening.
- ▶ Wear protective gloves as components can become very sharp through wear or damage.
- ▶ Remove spring-loaded components carefully (e.g. mechanical seal, tensioned bearing, valves etc.), as components can be ejected by the spring tension.
- ▶ Observe the manufacturer's specifications (e.g. for the motor, coupling, mechanical seal, blocking pressure system, cardan shaft, drives, belt drive etc.).

1. Observe the following during removal:
 - Mark the precise orientation and position of all components before dismantling them.
 - Dismount components concentrically without canting.
2. Dismount the pump (→ sectional and exploded drawing).

7.3.2 Returning the pump to the manufacturer

- ✓ Pump depressurized
 - ✓ Pump completely empty
 - ✓ Electrical connections disconnected and motor secured against being switched on again
 - ✓ Pump cooled down
 - ✓ Auxiliary systems shut down, depressurized and emptied
 - ✓ Pressure gauge lines, pressure gauge and holdings dismantled
1. Enclose a truthfully and fully completed clearance certificate when returning pumps or components to the manufacturer (→ 9.4 Clearance certificate, Page 39).
 2. Take necessary measures, depending on the required repair work, as listed in the table below when returning the pump to the manufacturer.

Repairs	Measure for return
...at the customer's premises	▶ Return the defective component to the manufacturer.
...at the manufacturer's premises	▶ Flush the pump and decontaminate it if it was used for hazardous pumped liquids.
...at the manufacturer's premises for warranty repairs	▶ Return the complete pump (not disassembled) to the manufacturer.

Tab. 8 Measures for returning the pump

7.3.3 Installing

 Install the components concentrically, without canting, in accordance with the markings made.

NOTE

Material damage due to unsuitable components!

- ▶ Always replace lost or damaged screws with screws of the same strength.
- ▶ Only replace seals with seals of the same material.

1. Observe the following during installation:
 - Replace worn parts with genuine spare parts.
 - Replace seals, inserting them in such a way that they are unable to rotate.
 - Adhere to the prescribed tightening torques (→ 9.2.4 Tightening torques, Page 33).
2. Clean all parts (→ 9.2.6 Cleaning agents, Page 33). Do not remove any markings which have been applied.
3. Replace the repair kit.
4. Installing the pump (→ 9.1 Sectional drawings, Page 30).
5. Installing the pump in the system (→ 5 Setup and connection, Page 15).

7.4 Ordering spare parts

 Keep a complete pump in storage to ensure it can be replaced without problems in the event of damage. Parts which can be replaced can be found in the parts list (→ 9.1.1 Parts list, Page 30).

- ▶ Have the following information ready to hand when ordering spare parts:
 - Pump type
 - Serial number
 - Year of manufacture
 - Part number
 - Designation
 - Quantity

8 Troubleshooting

⚠ DANGER

Risk of death and material damage due to magnetic field!

- ▶ Make sure that personnel who have a pacemaker fitted do not perform any work on the pump.
- ▶ Secure the work area. If necessary isolate the area:
 - Make sure that personnel with pacemakers keep a safe distance of at least 1 meter.
 - Make sure that no magnetizable metal parts can be attracted by the magnetic coupling of the pump.
 - Make sure that parts of the magnetic coupling cannot be attracted by the magnetizable metal parts.
- ▶ Keep all magnetically-sensitive objects at a safe distance of at least 150 mm from the magnetic coupling.

8.1 Pump malfunctions

If malfunctions occur which are not specified in the following table or cannot be traced back to the specified causes, please consult the manufacturer.

Possible malfunctions are identified by a number in the following table. This number identifies the respective cause and remedy in the troubleshooting list.

Fault	Number
Pump not pumping	1
Pumping rate insufficient	2
Pumping rate excessive	3
No pump suction	4
Pump running roughly or clattering	5
Pump jammed	6
Pump leaking	7
Excessive motor power uptake	8

Tab. 9 Fault number assignment

Fault number								Possible cause	Rectification
1	2	3	4	5	6	7	8		
X	-	-	-	-	-	-	-	Transport screw plugs still in place	<ul style="list-style-type: none"> ▶ Remove the transport screw plugs. ▶ Dismount the pump and inspect it for dry-running damage.
X	-	-	-	-	-	-	-	Supply/suction pipe closed by fitting	<ul style="list-style-type: none"> ▶ Open the fitting.
X	-	-	-	X	-	-	-	Supply/suction pipe not bled properly or not filled up completely	<ul style="list-style-type: none"> ▶ Fill up the pump and/or pipe completely and bleed them.
X	-	-	-	X	-	-	-	Formation of air pockets in the supply or suction pipe	<ul style="list-style-type: none"> ▶ Install the fitting for bleeding. ▶ Correct the piping layout.
X	-	-	-	X	-	-	-	Pressure pipe blocked	<ul style="list-style-type: none"> ▶ Clean the pressure pipe.
X	-	-	X	X	-	-	-	Pump running in the wrong direction	<ul style="list-style-type: none"> ▶ Swap any two phases on the motor (→ 5.5.2 Checking the direction of rotation, Page 18).
X	-	-	X	-	X	-	-	Pump very dirty	<ul style="list-style-type: none"> ▶ Dismount and clean the pump.
X	X	-	X	-	-	-	-	Magnetic coupling broken off	<ul style="list-style-type: none"> ▶ Turn off the pump and then turn it back on. ▶ Check the operating pressure of the pump if necessary (→ 9.2.1 Pump data, Page 33). ▶ If it breaks again, take the pump apart and clean the interior.
X	X	-	X	X	-	-	-	Supply/suction pipe, pump or suction strainer blocked or encrusted	<ul style="list-style-type: none"> ▶ Clean the supply/suction pipe, pump or suction strainer. ▶ Clean the suction strainer.
X	X	-	X	X	-	-	-	Air is sucked in	<ul style="list-style-type: none"> ▶ Seal the source of malfunction.
X	X	-	X	X	-	-	-	Excessive amount of gas: Pump is cavitating	<ul style="list-style-type: none"> ▶ Check the cable gland. ▶ Clean/enlarge the filter. ▶ Enlarge the supply/suction pipe cross-section.
X	X	-	X	X	-	-	-	Excess play between: <ul style="list-style-type: none"> • Gears • Gears and housing 	<ul style="list-style-type: none"> ▶ Repair or replace any worn parts.
-	X	-	X	-	-	-	-	Motor speed too low	<ul style="list-style-type: none"> ▶ Compare the required motor speed with the specifications on the pump type plate. Replace the motor if necessary. ▶ Increase the motor speed if speed control is available.
-	X	-	X	-	-	-	-	Supply/suction pipe not fully opened	<ul style="list-style-type: none"> ▶ Open the fitting.
-	X	-	X	X	-	-	-	Supply/suction pipe cross-section too narrow	<ul style="list-style-type: none"> ▶ Enlarge the supply/suction pipe cross-section. ▶ Remove any encrustations from the suction pipe. ▶ Open the fitting completely.
-	X	-	X	X	-	-	-	Suction height excessive: $NPSH_{pump}$ larger than $NPSH_{system}$	<ul style="list-style-type: none"> ▶ Increase the suction pressure or suction head. ▶ Consult the manufacturer.

Fault number								Possible cause	Rectification
1	2	3	4	5	6	7	8		
-	X	-	X	X	-	-	-	Pumped liquid temperature too high: Pump is cavitating	<ul style="list-style-type: none"> ▶ Increase the suction pressure or suction head. ▶ Lower the temperature. ▶ Consult the manufacturer.
-	X	-	X	X	-	-	-	Hydraulic parts of the pump dirty, clotted or encrusted	<ul style="list-style-type: none"> ▶ Dismount the pump. ▶ Clean the parts.
-	X	-	X	-	-	-	X	Viscosity or specific weight of the pumped liquid outside the range specified for the pump	<ul style="list-style-type: none"> ▶ Consult the manufacturer.
-	-	-	-	X	-	-	-	Pressure-side fitting not opened wide enough	<ul style="list-style-type: none"> ▶ Open the pressure-side fitting.
-	X	-	X	X	X	-	-	Pump parts worn	<ul style="list-style-type: none"> ▶ Replace the worn pump parts.
-	-	X	-	X	-	-	X	Motor speed too high	<ul style="list-style-type: none"> ▶ Compare the required motor speed with the specifications on the pump type plate. Replace the motor if necessary. ▶ Reduce the motor speed if speed control is available.
-	-	-	-	-	-	X	-	Tie bolts not tightened properly	<ul style="list-style-type: none"> ▶ Tighten the tie bolts (→ 9.2.4 Tightening torques, Page 33).
-	-	-	-	-	-	X	-	Housing seal defective	<ul style="list-style-type: none"> ▶ Replace the housing seal.
-	-	-	-	X	X	X	X	Pump distorted	<ul style="list-style-type: none"> ▶ Check the pipe connections and pump attachment.
-	X	-	X	X	-	-	X	Motor running on 2 phases	<ul style="list-style-type: none"> ▶ Check the fuse and replace it if necessary. ▶ Check the cable connections and insulation.

Tab. 10 Pump troubleshooting list

8.2 Pressure relief valve malfunctions

If malfunctions occur which are not specified in the following table or cannot be traced back to the specified causes, please consult the manufacturer.

Possible malfunctions are identified by a number in the following table. This number identifies the respective cause and remedy in the troubleshooting list.

Fault	Number
Pumping pressure drops	1
Pressure relief valve does not open	2
Pressure relief valve does not close	3
Pressure relief valve rattles	4

Tab. 11 Fault number assignment

Fault number				Possible cause	Rectification
1	2	3	4		
X	-	-	-	Spring worn out	▶ Install a new spring.
X	-	-	-	Valve seat leaks	▶ Install a new valve cone.
-	X	-	-	Spring tension too high	▶ Relieve the pressure on the spring by turning the adjusting screw, then reset the pressure relief valve.
-	X	-	-	Foreign particles in the valve	▶ Remove the pressure relief valve. ▶ Clean the internal parts. ▶ Install the pressure relief valve.
-	X	-	-	Pump operating temperature too high	▶ Consult the manufacturer.
-	-	X	-	Spring has no or insufficient tension	▶ Reset the pressure relief valve.
-	-	X	-	Valve seat leaks	▶ Rework or replace the valve cone or valve casing.
-	-	-	X	Pressure relief valve rattles	▶ Measure the excess pressure with the fitting on the pressure side closed. ▶ Reset the pressure relief valve (opening pressure 10% higher than the operating pressure).

Tab. 12 Pressure relief valve troubleshooting list

9 Appendix

9.1 Sectional drawings

9.1.1 Parts list

Part no.	Designation
1	Mounting plate bolts
2	Mounting plate
3	Fastening bolts
4	Magnet can
7	Inner magnet
9	O-ring
10	Pump housing
11	Bearing
12	Driving gear unit
13	Driven gear unit
14	Cylindrical pin
15	Cavity plate
16	Cap
17	Pump head bolts
18	Pressure relief valve setting screw
19	Pressure relief valve nut
20	Pressure relief valve (spring, guide, valve plate)

Tab. 13 Designation of the components
VGS015-380 series

Part no.	Designation
1	Pump head bolts
2	Fastening plate bolt
3	Mounting plate
4	Pump housing
5	Cavity plate
6	Cap
7	Pump head bolts (for mounting parts no. 3,4,5,6)
8	Pump head bolts (for mounting parts no. 4,5,6)
9	Driven gear unit
10	Cylindrical pin
11	Mounting plate bolts
12	Magnet can
13	Fastening plate
14	Inner magnet
15	Magnet screw
16	Magnet pin
17	Driving gear unit
18	Bearing
19	O-ring
20	O-ring
21	O-ring

Tab. 14 Designation of the components
VGS430-1300 series

9.1.2 Sectional drawings

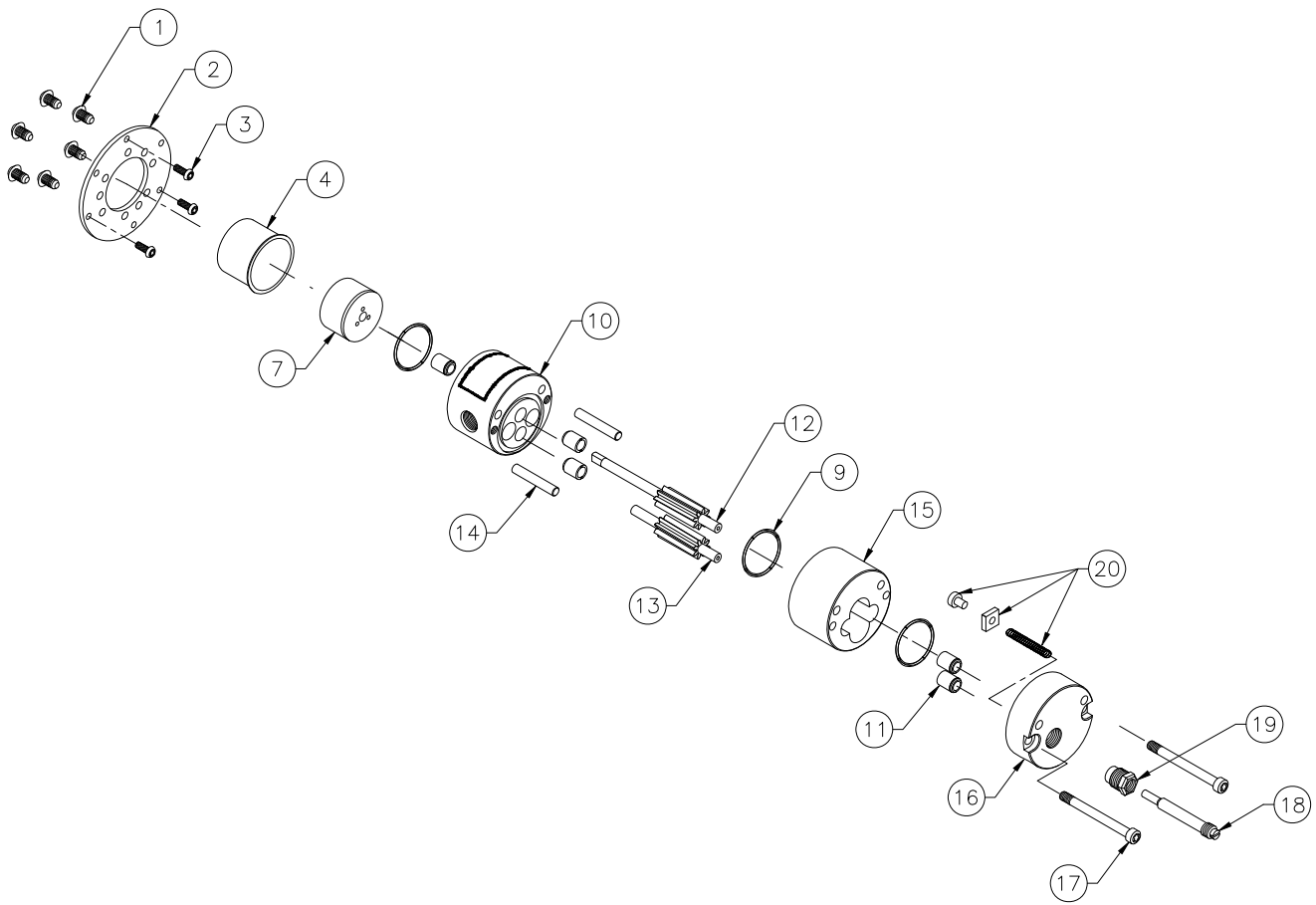

Fig. 4 Sectional drawing of VGS015-380 series

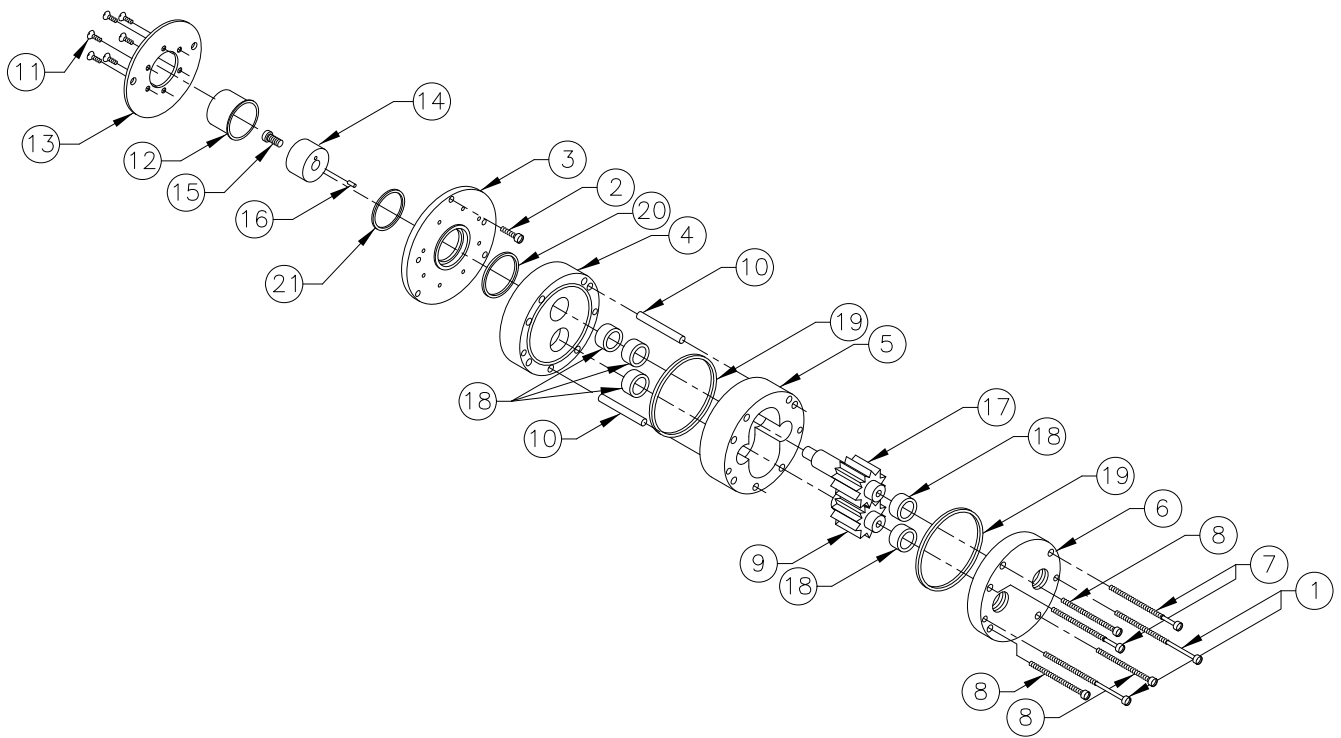

Fig. 5 Sectional drawing of VGS430-1300 series

9.2 Technical specifications

9.2.1 Pump data

Size	Value
Max. differential pressure (suction side to pressure side)	5 bar – 17 bar
Max. system pressure	34 bar
Max. suction vacuum	0.97 bar
Pumped liquid Viscosity	Non-corrosive 1.0 cSt – 10,000 cSt (mm ² /s)
Median temperature	< 175 °C
Motor speed	50 rpm – 5,000 rpm
Dimensions	→ dimensions sheet
Pressure relief valve	0 bar – 16 bar (adjustable)

Tab. 15 Pump data

9.2.2 Ambient conditions

 Operation under any other ambient conditions should be agreed with the manufacturer.

Operating conditions

- Ambient temperature -46 °C to +176 °C
- Relative humidity
 - Long-term ≤ 85 %
 - Briefly ≤ 100 %
- Setup height above sea level ≤ 1000

Storage conditions

- Ambient temperature +10 °C to +50 °C
- Relative humidity
 - Long-term ≤ 85 %
 - Briefly ≤ 100 %

9.2.3 Sound pressure level

Sound pressure level < 50 dB(A)

Measuring conditions:

- Speed 2,500 rpm
- Operating pressure 2 bar
- Operating temperature 20 °C
- Pumped liquid 1 cSt, non-lubricating

9.2.4 Tightening torques

 The following values apply to oiled screws and torque tightening processes.

Thread size	Quality	Tightening torque [Nm]
M 6	5.6	3.9
M 8		9.8
M 10		18.6
M 12		32.3
M 16		78.4
M 20		156.8
M 24		289.1
M 27		426.3
M 30		578.2
M 6		8.8
M 8	21.6	
M 10	43.1	
M 12	73.5	
M 16	181.3	
M 20	352.8	
M 24	661.5	
M 27	975.1	
M 30	1323.0	
M 6	10.9	
M 8		31.8
M 10		63.0
M 12		108.0
M 16		264.0
M 20		517.0
M 24		890.0
M 27		1304.0
M 30		1775.0

Tab. 16 Tightening torques

9.2.5 Preservatives

 Use RUST-BAN 335 as a preservative, for example.

9.2.6 Cleaning agents

Application area	Cleaning agents
Other	Benzine, wax solvents, diesel, paraffin, alkaline cleaners

Tab. 17 Cleaning agents

9.3 Performance curves

VGS015.17

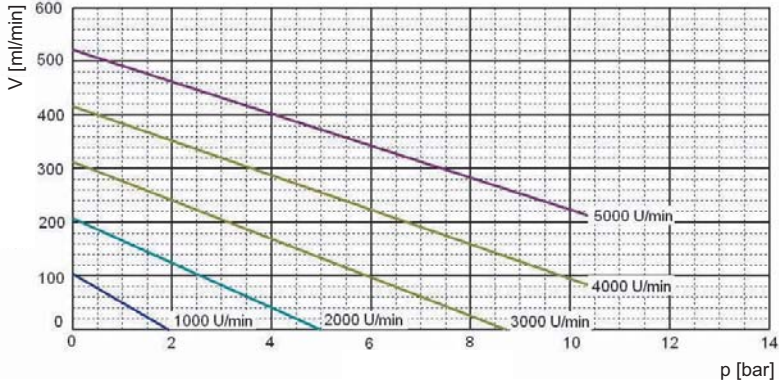

VGS040.17

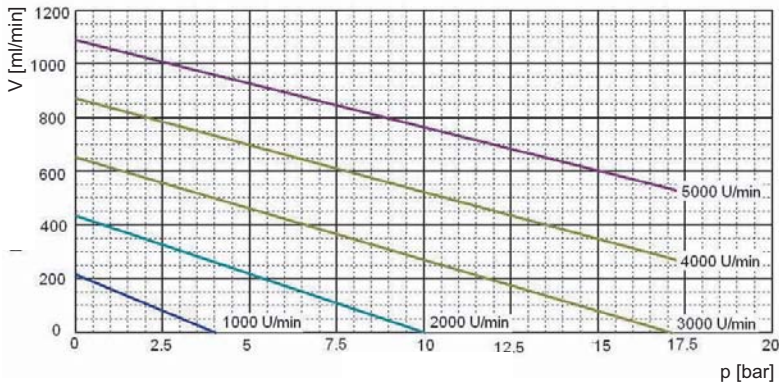

VGS060.17

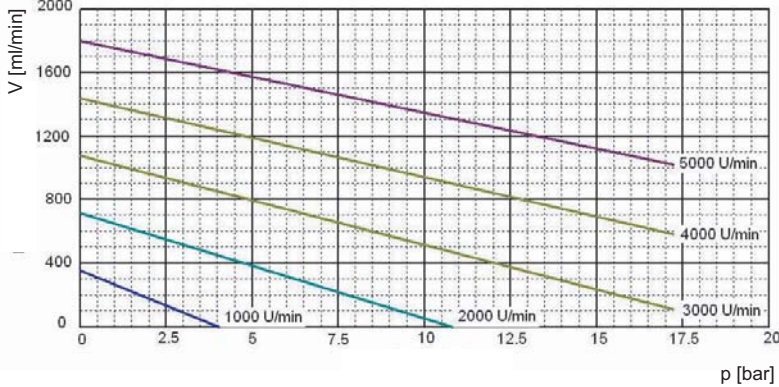

VGS096.17

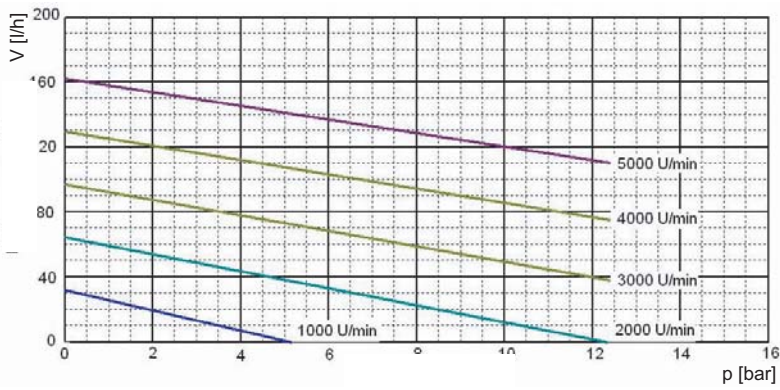

VGS120.17

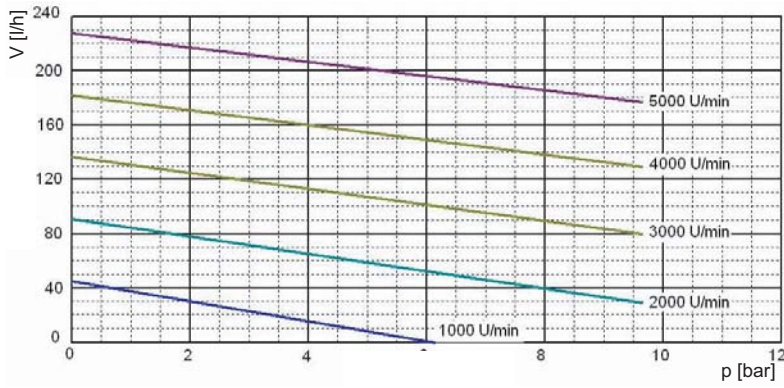

VGS200.17

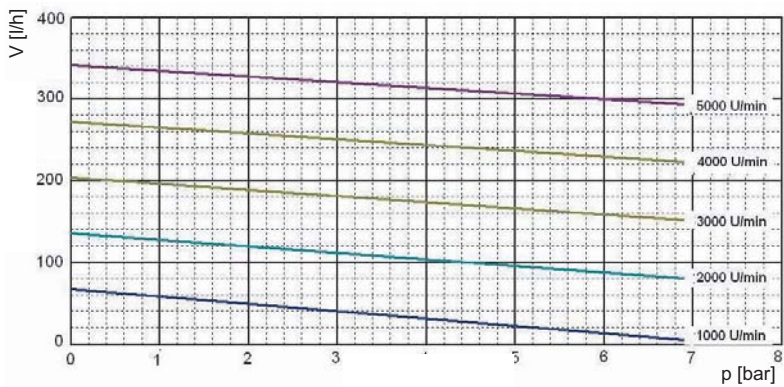

VGS260.07

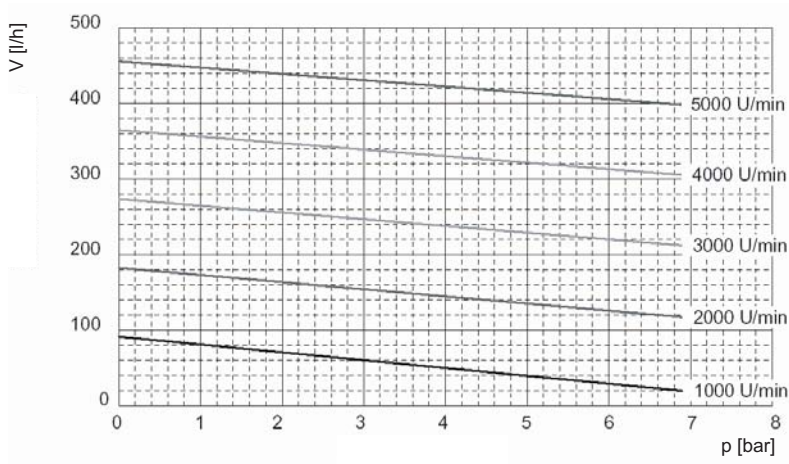

VGS330.07

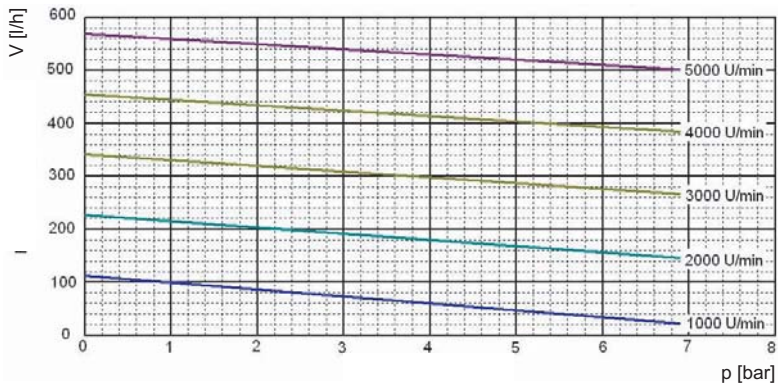

VGS380.07

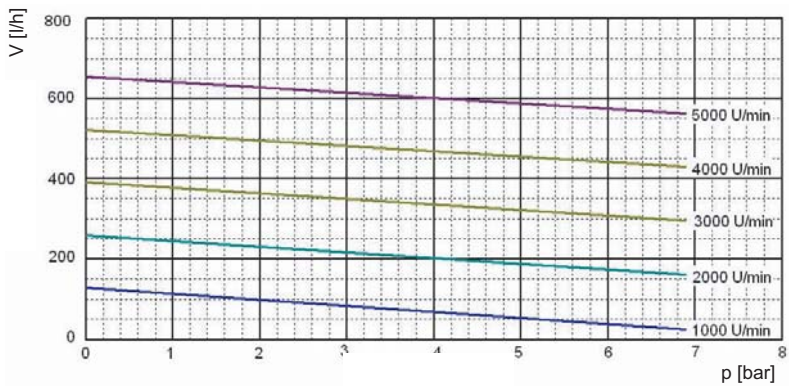

VGS430.10

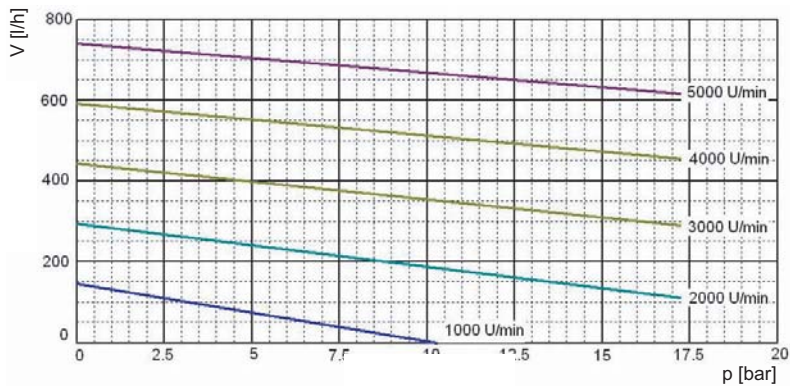

VGS870.07

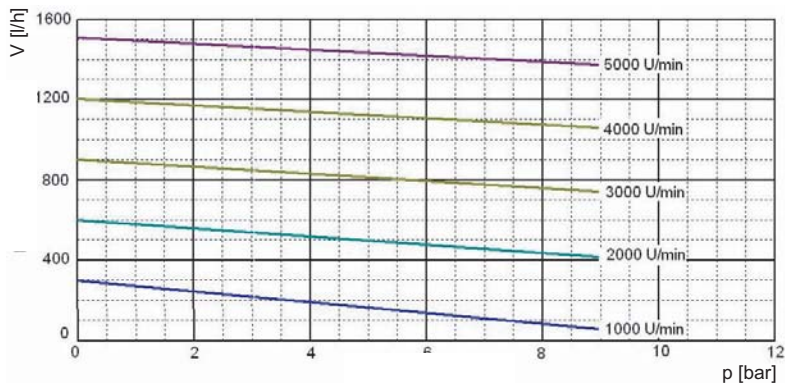

VGS1300.05

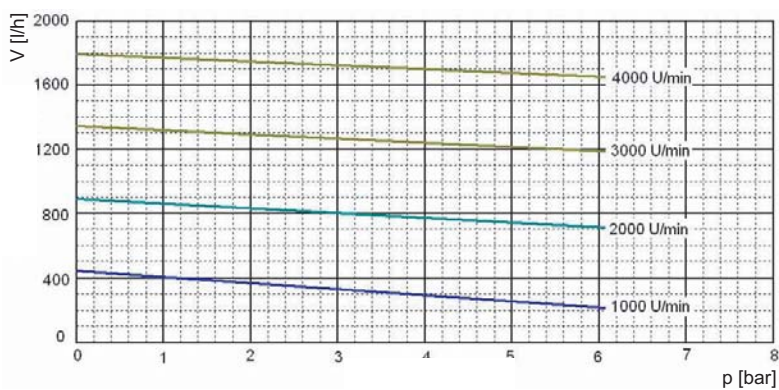

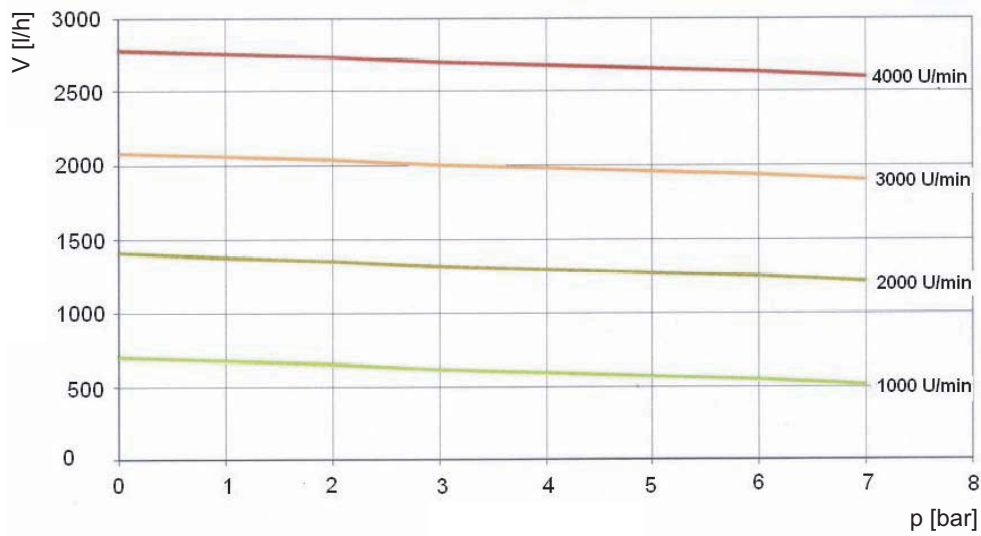
VGS2000.07

9.4 Clearance certificate

 Please copy this document and send it together with the pump.

The pump and accessories submitted for inspection / repairs together with the safety certificate by us, the signatory:

Type: _____ Delivery date: _____

Part no.: _____ Order no.: _____

Reason for inspection / repair: _____

Was not used with liquids that are hazardous to health or the environment.

Was used for the following application: _____
 Came into contact with liquids that must be labeled for safety or are considered to be polluting.

Last pumped liquid: _____

The pump has been carefully emptied and cleaned on the outside and inside prior to delivery or provision.

Special safety precautions are not necessary for subsequent handling.

The following safety precautions regarding rinsing liquids, liquid residue and disposal are necessary: _____

 If the pump was used with critical liquids, please make sure you enclose a **safety data sheet** in the package.

We hereby declare that the information given is correct and complete, and that the pump is being shipped in accordance with legal requirements.

Company / address: _____ Phone: _____

_____ Fax: _____

Customer no.: _____

Name of issuer: (capital letters) _____ Position: _____

Date: _____ Company stamp / signature: _____

Tab. 18 Clearance certificate

9.5 Declaration of conformity according to EC Machine Directive

 The following declaration does not contain serial numbers or signatures. The original declaration is delivered with the respective pump.

Declaration of conformity

<p>EC declaration of conformity according to Machine Directive, Appendix II A</p> <p>We, VERDER Deutschland GmbH & Co. KG, Retsch-Allee 1 – 5, 42781 Haan, Germany hereby declare that the following machine adheres to the relevant EC Directives detailed below:</p> <p>Serial number _____</p> <p>Designation <u>VGS015 ... VGS2000</u></p> <p>Order no. _____</p> <p>EC Directives:</p> <ul style="list-style-type: none"> • Machine Directive (2006/42/EC) • Low-voltage Directive (2006/95/EC) • EMC Directive (2004/108/EC) <p>Applicable harmonized norms:</p> <ul style="list-style-type: none"> • EN ISO 12100:2010 • EN 60204-1:2011-01 		
<p>Responsible for the documentation</p> <p style="text-align: right;">Verder Deutschland GmbH & Co. KG Retsch-Allee 1 – 5 42781 Haan, Germany</p>		
<p>Date: 10/01/2012</p>	<p>Company stamp / signature:</p> <p style="text-align: center;">Head of Development/Construction</p>	<p>Company stamp / signature:</p> <p style="text-align: center;">Head of Quality</p>

Tab. 19 Declaration of conformity according to EC Machine Directive